



THE STABILITY OF STANDARD-FREQUENCY OSCILLATORS

In the measurement of physical quantities, the demands of science, industry, and the military are for constant improvement in accuracy. Standards and measuring devices, as a result, must meet ever tighter specifications. This trend is well illustrated by Figure 1, which shows the increase in accuracy of the U. S. Frequency Standard over a period of some 40 years.

Atomic frequency control, which is used in the U. S. Frequency Standard, provides both the best accuracy and the best long-term stability. At present, however, there is little indication that

it will replace the quartz-crystal oscillator as a working standard. There are two reasons for this: Atomic frequency control devices — at least those that have been available commercially — not only have been very expensive but have demonstrated a serious lack of reliability.

LONG-TERM STABILITY

In the crystal oscillator, the long-term stability of the quartz crystal itself has been the limiting factor. Most standard-frequency oscillators use either the 5-Mc or the 2.5-Mc fifth-overtone

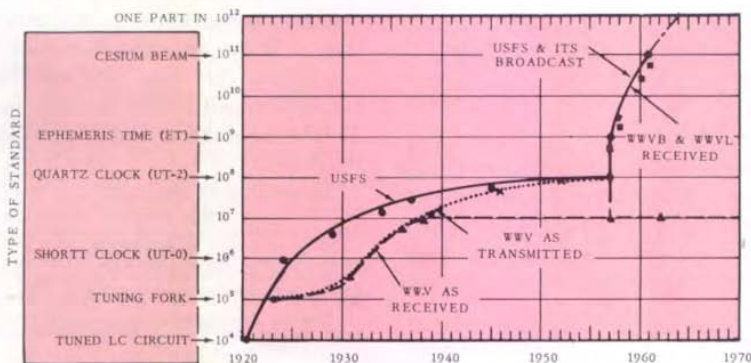

Figure 1. Accuracy trend of the U. S. Frequency Standard.

IN THIS ISSUE

Bridge Oscillator-Detector
Inductance Measuring Assembly
Stage-Lighting Control





crystals¹ developed by Bell Telephone Laboratories. Their ultimate aging rates are less than 1 in 10¹⁰ per day for the 5-Mc unit and less than 1 in 10¹¹ per day for the 2.5-Mc. The choice between the two frequencies is generally dictated by cost and convenience. The 2.5-Mc crystal is twice as large as the 5-Mc and much more expensive; in addition, for comparable performance, it requires better (dynamic) temperature control.

Development work on quartz crystals is continuing, and better units can be expected in the future.² Present well-designed oscillator circuits do not contribute to long-term frequency drift (aging) to any measurable extent, and any improvement in the crystal characteristics will be directly reflected in the over-all stability of the oscillator.

SHORT-TERM STABILITY

The short-term stability of a crystal oscillator (defined here as the frequency deviations for averaging times from 100 μsec to 10 sec) is, at the longer averaging times, predominantly controlled by oscillator defects and, for very short averaging times, approaches the limits set by the thermal noise of the crystal.

Thermal Noise

It has been shown³ that the equivalent noise resistance of a quartz crystal is the same as the effective series resistance and that the frequency deviation due to this source can be expressed as

$$\frac{\Delta f}{f} = \frac{2\pi E_N}{\tau f_o E_S} \tag{1}$$

where τ = averaging time.
 f_o = oscillator frequency.
 E_N = noise voltage.
 E_S = signal voltage.

or, expressing E_N and E_S by

$$E_N = \sqrt{4kTBR}$$

and

$$E_S = \sqrt{PR},$$

then

$$\frac{\Delta f}{f} = \frac{2\pi}{\tau} \sqrt{\frac{4kTB}{P}} \tag{2}$$

and, with $B = \frac{1}{Q}f_o$,

$$\frac{\Delta f}{f} = \frac{2\pi}{\tau} \sqrt{\frac{4kT}{PQf_o}} \tag{3}$$

where R = effective series resistance.
 T = absolute temperature.
 B = bandwidth of network.
 P = quartz driving power.
 k = Boltzmann's constant.
 Q = storage factor of quartz.

Equation (3) indicates that:

1. The observed frequency deviation is inversely proportional to the averaging time τ . If the measured deviation does not follow this rule, the stability is not determined by the crystal alone.
2. Increasing the crystal drive improves the stability.
3. Increasing Q improves the stability.

¹A. W. Warner, "High-Frequency Crystal Units for Primary Frequency Standards," *Proceedings of the IRE*, Vol 40, pp 1030-1033, September 1952.
²A. W. Warner, "Use of Parallel Field Excitation in the Design of Quartz Crystal Units," *Proceedings of the 17th Annual Symposium on Frequency Control*, 1963, pp 248-266.
³E. Hafner, "Stability of Crystal Oscillators," *Proceedings of the 14th Annual Symposium on Frequency Control*, 1960, pp 192-199.

CONTENTS OF THIS ISSUE

The Stability of Standard-Frequency Oscillators	1
Papers Sought for Conference on Automotive Electrical and Electronics Engineering	16
Convenient Generator-Detector Unit for Bridge Measurements	17
Bridge Assembly for Precision Inductance Measurement	17
Inexpensive Variac [®] autotransformer Lighting Control	18
Melville Eastham, 1885-1964	20





4. Higher oscillator frequency improves stability.

For these precision crystals, however, statement 3 is dependent on 4 because the maximum Q is inversely proportional to the frequency⁴ and Qf_0 is constant.

As an example, if we substitute these typical crystal constants in equation (3):

$$f_0 = 5 \times 10^6 \quad P = 0.7 \times 10^{-6}$$

$$Q = 2.5 \times 10^6 \quad T = 350^\circ\text{K}$$

then

$$\frac{\Delta f}{f} = \frac{3 \times 10^{-13}}{\tau}$$

This means that, for a one-second averaging time, the frequency deviations due to the thermal noise of the crystal do not exceed 3×10^{-13} .

How close do modern crystal oscillators get to this figure? Actual measurements on the new General Radio Type 1115-B Standard-Frequency Oscillators have shown the following results:

$$\frac{\Delta f}{f} = 4 \times 10^{-12} \text{ for one-second averaging time}$$

$$= 4 \times 10^{-10} \text{ for one-millisecond averaging time.}$$

This shows that, for a one-second averaging time, the oscillator circuit contributes just over one order of magnitude more than the crystal. For one millisecond, the effects of the circuit are almost negligible, as the measured stability is only 35% worse than that of the crystal alone. Figure 2 shows the theoretical stability as well as some measured data.

From the discussion above it appears that present oscillator designs are satisfactory for very long averaging times (aging) and very short averaging times. In between, say from tenths of seconds

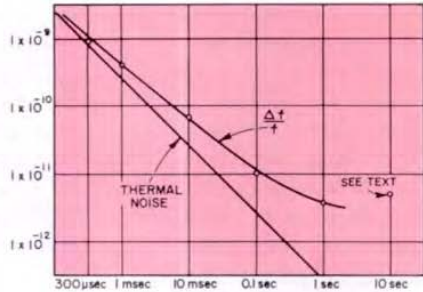

Figure 2. Theoretical and measured stability of a crystal oscillator.

to hundreds of seconds, the stability potential of the crystal is not fully utilized. This is only partially correct, however, as there is temperature disturbance caused by the crystal, which is significant for averaging times of tens to hundreds of seconds.

Temperature Gradients

Crystal units generally show great sensitivity to temperature gradients. In a vacuum-mounted crystal, heat is conducted to the quartz mostly through the wire supports, and rapid temperature fluctuations can produce spot temperature differences, creating a temperature gradient in the crystal. Thus, if the temperature of the oven fluctuates but little, the frequency effects are much larger than those due to the temperature coefficient alone. Temperature-control circuits, like any other circuit, are susceptible to noise, and some temperature fluctuations are inevitable. Temperature rates of change as low as 10 millionths of a degree per second (2×10^{-6} °C/sec) are sufficient to cause frequency changes larger than those indicated by the steady-state temperature coefficient of the crystal.⁵

⁴A. W. Warner, "Design and Performance of 2.5 Mc Quartz Crystal Units," *BSTJ*, Vol XXXIX, No. 5, September 1960, pp 1193-1217.

⁵Contract DA 36-039 SC 73078, "An Ultra Precise Standard of Frequency," *Eleventh Interim Report* (Bell Telephone Laboratories), pp 33-37, April 23, 1959.



The limiting factor in the tenths-to-seconds range is the $1/f$ noise of the oscillator and level-control circuits. For higher frequencies (above 1 kc) the noise figure of the semiconductors is quite small, say a few db, but, as we go to lower frequencies, beyond the low-frequency noise corner, the spot noise figure gets much larger. It is not easy to decide whether this effect is due to nonlinearities in the oscillator circuit or to the level sensitivity of the crystal.

Drive Level

At the normal operating point of 70 microamperes, the 5-Mc crystal shows about 1×10^{-9} /db for level sensitivity.⁶ This sensitivity increases with increasing crystal current and for moderate drive levels is approximately:

$$\frac{\Delta f}{f_0} = Di^2 \quad (4)$$

where f_0 = frequency at zero driving power.

D = a constant determined by the type of crystal and is about 1 for the 5-Mc crystal.

i = crystal current.

Figure 3 shows how, as the driving power is increased, the relative drive

⁶A. W. Warner, "Crystal Unit Design for Use in a Ground Station Frequency Standard," *Proceedings of the 10th Annual Symposium on Frequency Control, 1956*, pp 190-196.

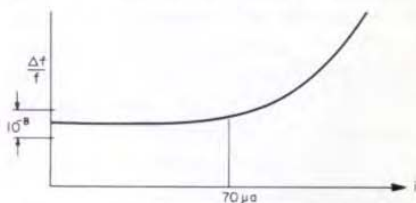

Figure 3. Drive-level sensitivity of 5-Mc crystal.⁶

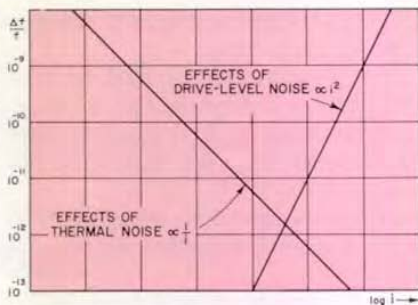

Figure 4. Effects of crystal current on short-term stability.

level becomes more and more critical. For a 1-db change in level,

$$\frac{\Delta f}{f_0} = 0.2 Di^2 \quad (5)$$

This effect is in the opposite direction from the effect of drive level on thermal noise (see equation (3) and statement 2). As a result, the drive level can be increased only up to a certain point. For higher levels, the fluctuations (i.e., noise) from the level-control circuit become predominant, and the over-all performance is poorer.

Figure 4 shows a typical relation for $\tau =$ one second. As the level-control circuitry is improved, higher and higher drive levels can be used. The thermal noise decreases as $1/i$, but the disturbance due to level sensitivity increases as i^2 . The best compromise is dictated by the performance of the level-control circuitry. For the 5-Mc crystal, operating at one-microwatt drive, level variations must be less than 0.01% to keep the resultant frequency disturbances to less than 1×10^{-12} . This calls for a drive-level stability of about 1×10^{-10} watt. The fact that this stability has to be achieved at high frequencies does not make the task any easier.



ADDITIONAL STABILITY PARAMETERS

Other factors affecting the short-term stability are temperature, load changes, vibration, and power-supply effects. In general, they are specified separately from the short-term stability data.

Temperature Control

The effects of temperature can be reduced to acceptable amounts depending only on economics of cost, weight, and power consumption. The most difficult factor is dynamic stability, i.e., the elimination of transient temperature changes much larger than steady-state changes for the same ambient range. Present-day instruments show over-all temperature coefficients as low as a few parts in 10^{12} per degree C. Under laboratory conditions this can be considered negligible because it is masked by either thermal noise or aging, except possibly in the range of $\tau = 0.1$ to $\tau = 1000$ seconds. If the requirements of the contemplated applications warrant the expense, temperature control can be improved. This will be necessary if and when active devices with lower $1/f$ noise and crystals with lower aging rates are available. While two-stage ovens are more popular, single-stage ovens can be made to perform quite well. Reduction of ambient changes as seen by the crystal is not limited by the stabilization factor of the oven control but by temperature gradients between the crystal and the temperature-sensing element. Although two-stage ovens are easier to design for low gradients and stability of the control system, single-stage ovens can be built with stabilization factors over 50,000 and gradients of less than 10 millidegrees Centigrade. They have the advantages of lower cost and lower complexity, and,

Figure 5. Vector diagram showing phase shift due to stray coupling to output.

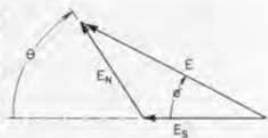

often most important, they require less power or less volume.

Loading

Frequency variations due to changes in the loading at the output of the oscillator have been a very serious problem for all laboratory applications. Loading effects are caused primarily by pickup of output current in the oscillator circuit. Let us assume that a small amount of output signal is introduced into the oscillator loop. Figure 5 shows this case in exaggerated form. From the vector diagram in Figure 5,

$$E = \sqrt{(E_S + E_N \cos \theta)^2 + (E_N \sin \theta)^2} \quad (6)$$

and

$$\tan \phi = \frac{\sin \theta}{\frac{E_S}{E_N} + \cos \theta} \quad (7)$$

where E_S = the signal in the loop without pickup.

E_N = the pickup.

E = the sum of both.

It is obvious that, regardless of the magnitude of E_N , ϕ is zero if θ is zero, and a maximum of ϕ occurs for

$$\theta = \pm 2(n-1)\frac{\pi}{2}$$

If a phase shift occurs inside the oscillator circuit, the frequency must shift to produce phase shift of equal magnitude but of opposite sign in the crystal network. The frequency shift due to such phase shift is

$$\frac{\Delta f}{f} = \frac{\tan \phi}{2Q} \quad (8)$$

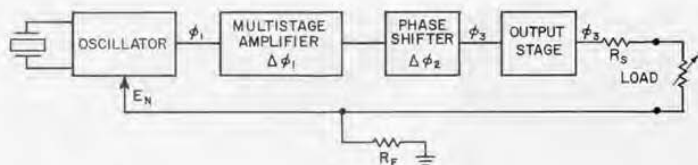

Figure 6. Typical block diagram for a precision oscillator.

and, as a function of θ ,

$$\frac{\Delta f}{f} = \frac{1}{2Q} \frac{\sin \theta}{\frac{E_N}{E_S} + \cos \theta}$$

$$\text{and, if } E_S \gg E_N, \frac{\Delta f}{f} \approx \frac{1}{2Q} \frac{E_N}{E_S} \sin \theta \quad (9)$$

Obviously, the best solution would be to ensure that E_N is small enough to be negligible. This is quite difficult, because even when E_N is very small, it still has considerable effect. For example, if

$$E_N = 1 \times 10^{-5}, E_S = 1 \times 10^{-2},$$

$$\text{and } Q = 2.5 \times 10^5$$

then

$$\frac{\Delta f}{f} = 2 \times 10^{-10} \sin \theta$$

To keep E_N as low as 1×10^{-5} requires well over 100 db of isolation and shielding between output stage and oscillator, and E_N is often larger. So far, it has been shown only that the frequency is offset owing to pick-up if θ is not equal to zero or 180° . As soon as E_N changes (owing to a change in output current), this frequency offset changes unless θ is zero or 180° .

If it could be ensured that θ is zero or 180° for all conditions of loading, no frequency changes would occur. As long as the load is strictly resistive, this is possible. Figure 6 is a block diagram of an oscillator with amplifier stages.

The conditions to make $\theta = 0$ are $\phi_1 = \phi_3$, which requires $\Delta\phi_1 + \Delta\phi_2 = 0$ for any resistive load.

The phase-shifter shown in Figure 6 can be the tank circuit of one of the

amplifier stages, which can be detuned slightly to compensate for whatever phase shifts may exist in all amplifier stages. Under these conditions, any resistive load change will affect the magnitude of E_N but not the phase. Changes in magnitude are not very important, since they represent no more than a change in gain in the oscillator loop, which is taken care of by the level-control circuit.

This condition cannot be met if either the output impedance or the load impedance is not strictly resistive. Any reactive load causes a phase shift as long as R_S is not zero, and, if the source impedance is reactive, resistive load changes result in variations of θ . The best compromise is to make R_S as small as possible, so that moderately reactive loads are acceptable.

It is not likely that load changes are reflected through the chain of amplifier stages. Experiments have shown that as few as two or three stages after the oscillator will provide all the isolation needed, but a larger number of stages is usually required to obtain enough gain.

Vibration

Crystal units are quite sensitive to vibration, and, while this problem is most severe for missile or airborne applications, it cannot be ignored for laboratory applications. Great efforts have been made to develop crystals with low sensitivity to acceleration.⁷

⁷ Contract DA 36-039 SC 73078. "An Ultra Precise Standard of Frequency," *Final Report* (Bell Telephone Laboratories), December 1960.



Precision crystals have frequency-*vs*-acceleration coefficients of 1×10^{-9} to 1×10^{-10} per g (gravitational constant), and efforts have been concentrated in the direction of eliminating resonances in the frequency range of interest. Once the crystal design ensures freedom from resonances, little more can be done in the way of mounting it in the instrument — at least not for low frequencies.

Power Supply

Power-supply variations can be held to a few parts in 10^{11} as oscillator voltage coefficients of less than 5×10^{-9} per volt are usual.

STABILITY SPECIFICATIONS

No accepted standards exist for the specification of short-term stability. These data are obtained for constant operating conditions, i.e., constant ambient, load, line, etc., and the effects of variations in these quantities are listed separately. The method most suitable for the evaluation of the oscillator performance in systems applications is to specify the "standard deviation," σ , for a specified confidence limit. This is, of course, the same as the "rms deviation." Sometimes rms phase deviation is listed as a measure of short-term stability. This phase deviation can be computed from the frequency:

$$\Delta\phi = (2\pi f) \frac{\Delta f}{f} \tau \quad (10)$$

where τ is the averaging time.

If the value of $\frac{\Delta f}{f}$ is in terms of rms units, the $\Delta\phi$ is also in rms units.

The term "short-term stability" is not generally used for averaging times

over 10 seconds; to fill the gap between 10 seconds and the averaging times for aging or drift, the term "fluctuations" has been used. For increasing averaging times, the rms values become less and less useful because the frequency fluctuates around a mean value that is changing very slowly as a result of aging. To state a meaningful rms value, it is necessary to subtract the aging slope. Such a regression analysis can easily be accomplished. The data so obtained become more and more important as the aging rate decreases with time and may ultimately determine the usable stability on a day-to-day basis.

SPECTRUM

Spectral purity is particularly important for microwave-spectroscopy and for other applications requiring high multiplication ratios. The spectrum of an oscillator provides information beyond that given by long-term and short-term stabilities. It shows the presence of discrete sidebands and the distribution of noise. To compare the spectra of two oscillators, it is necessary to know the frequency and the analyzer band-width. Figure 7 shows a typical spectrum, which is obtained by the

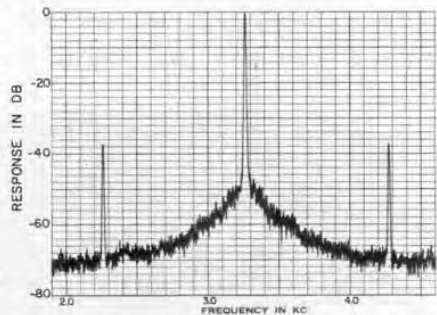

Figure 7. Spectrum showing discrete 1-kc sidebands at 10 Gc with 10-cycle bandwidth in analyzer.



multiplication of the frequencies of two oscillators to 10 Gc. These frequencies are adjusted to be about 3×10^{-7} apart (slightly over 3 kc at 10 Gc). The center line of the spectrum is adjusted for 0 db. The first sidebands are just visible at about -46 db, discrete sidebands of -37 db are at ± 1 kc from the carrier, and the noise pedestal is about -70 db. Such a spectrum can be used to predict the performance at any other frequency and for different bandwidths.

To obtain the ratio of noise to signal at other frequencies, the following approximation may be used as long as the noise-to-signal ratios are at least -20 db, i.e., if the noise is better than 20 db down:

$$N_2 = 20 \log \frac{f_2}{f_1} + N_1 \quad [\text{db}] \quad (11)$$

where N_2 is the noise-to-signal ratio at f_2 and N_1 at f_1 , in db.

This means that multiplying the frequency 10 times increases the noise-to-signal ratio by a factor of 10. To evalu-

ate the noise for a different analyzer bandwidth, it is convenient to express the noise in terms of root-cycle bandwidth. This is the noise-to-signal ratio for a one-cycle bandwidth.

$$N_{\text{norm}} = N_2 - 10 \log B \quad (12)$$

where B = bandwidth.

The relative amplitude of discrete sidebands is not affected by any change of bandwidth. Using these relations to refer the spectrum shown in Figure 7 to 5 Mc, we have

- $f_1 = 10 \text{ Gc}$ $f_2 = 5 \text{ Mc}$
- analyzer bandwidth = 10 cps
- $N_1 = -37 \text{ db}$ for the ± 1 -kc sidebands.
- $N_1 = -70 \text{ db}$ for the noise pedestal.
- Then, from (11)
- $N_2 = -103 \text{ db}$ for sidebands.
- $N_2 = -136 \text{ db}$ for noise in 10-cycle bandwidth
- and from (12)
- $N_2 = -146 \text{ db}$ for noise in one-cycle bandwidth.

TYPE 1115-B STANDARD-FREQUENCY OSCILLATOR

Careful evaluation of the basic oscillator parameters, as outlined above, has led to the design of this new oscillator unit. From the beginning it was agreed that the unit should use the 5-Mc, 5th-

overtone crystal, include frequency dividers to 1 Mc and 100 kc, and have self-contained emergency power for at least 24 hours. The choice of the 5-Mc crystal was dictated by the belief that

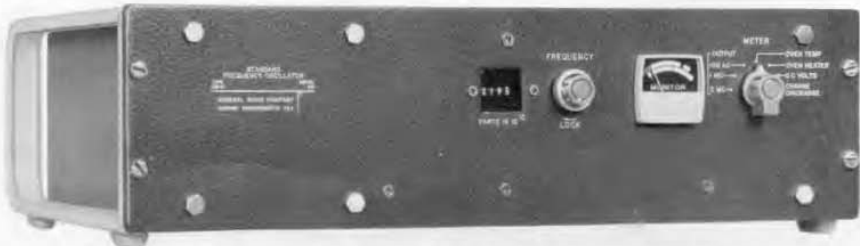

Figure 8. Panel view of Type 1115-B Standard-Frequency Oscillator.



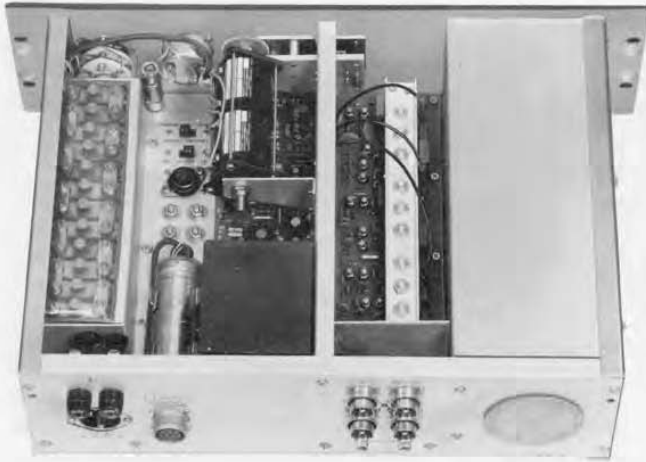

Figure 9. View of oscillator with cover removed.

this unit could meet the requirements for working standards of the majority of users at a cost substantially lower than that of 2.5-Mc units. Except for aging of the crystal, the GR TYPE 1115-B shows a performance comparable to or exceeding that of any 2.5-Mc oscillator.

Figure 10 is a block diagram of this unit. The crystal, oscillator, and AGC circuits are housed in a single-stage proportional-control oven. Two stages of isolation amplifiers and the output amplifier follow. Regenerative dividers are used to divide to 1 Mc and 100 kc.

The power supply consists of an automatic battery charger, explosion-proof battery, and regulator.

The crystal is a gettered unit. No long-term aging data are available at this time, but a record of several months' aging shows some improvement over the aging characteristics of ungettered units. One important advantage of the gettered units is a better restarting characteristic, i.e., if the oscillator has been off and is turned on again, these units settle down much faster than do the ungettered ones.

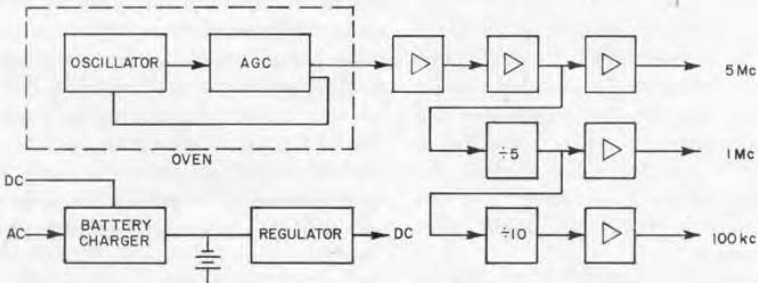

Figure 10. Block diagram of Standard Frequency-Oscillator.



OSCILLATOR AND AGC

The effects of component changes on the frequency of a crystal oscillator have been analyzed in the past.⁸ Figure 11 shows the basic arrangement of the crystal network and oscillator circuit. For the 5-Mc, 5th-overtone crystal, a 1-pf change of C_1 or C_2 (0.3%) amounts to a frequency variation of about 5×10^{-10} . The shunt capacitances C_1 and C_2 are about 330 pf each, and this network requires a transconductance of 15 milliamperes per volt to sustain oscillations. Such a transconductance would be difficult to achieve with vacuum tubes of stable long-term performance but can be obtained with transistor circuits.

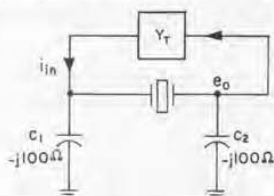

Figure 11. Basic oscillator network.

The ideal, active device for Y_T has high input and output resistance and no input or output capacitance. In addition, the magnitude of Y_T must be controlled by the AGC circuit to hold the amplitude constant. The gain of transistors is usually controlled by variation of the dc current. This method, however, is undesirable, because the current variation changes the capacitances of the transistors. Better performance is obtained if only the ac gain, and not the dc operating point, is varied. The circuit shown in Figure 12 meets these requirements.

Transistors Q_1 and Q_2 are in a circuit configuration that applies 100% feed-

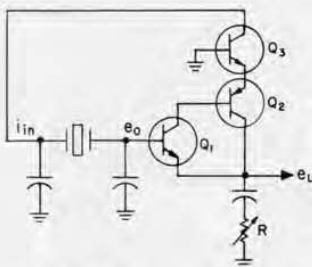

Figure 12. Basic oscillator circuit.

back from the output to the emitter of the input stage Q_1 . The voltage gain from the base of Q_1 to the output terminal is very nearly unity. If we assume that R is the only impedance from this point to ground, the current

through R will be very nearly $\frac{e_o}{R}$. Be-

cause this same current flows through Q_3 (with the exception of small amounts lost through the bases of Q_1 and Q_3), the transconductance of this circuit is predominantly controlled by R . This resistance can be varied with no change in the dc operating point of any of the transistors. The circuit has an input impedance of over 30 kilohms shunted by less than 2 pf and an output impedance of several hundred kilohms shunted by less than 2 pf. A transconductance of 15 milliamperes per volt is readily obtained when R is about 65 ohms. Because of these high input and output impedances, variations of transistor parameters are of little consequence. As the collector-to-base capacitances of modern planar transistors are typically stable to better than 10% per 10,000 hours at constant temperature and voltage, the resultant change of

⁸ E. P. Felch and J. O. Israel, "A Simple Circuit for Frequency Standards Employing Overtone Crystals," *Proceedings of the IRE*, Vol 43, No. 5, pp 596-603, May 1955.

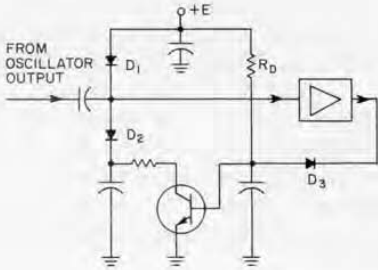

Figure 13. Basic AGC circuit.

frequency is less than 1×10^{-10} per year. This is negligible compared with the aging of 5-Mc crystals, which is orders of magnitude greater.

Electronic control of the transconductance is obtained by variation of the dc bias current through a pair of diodes (Figure 13). The rf output of the oscillator is amplified by a two-stage amplifier and rectified by D_3 . As long as there is no rf voltage, R_D is biased on (saturated) to pass a maximum of current through the AGC diodes, D_1 and D_2 , for maximum transconductance to start the oscillations. As the amplitude increases, D_3 reduces the turn-on drive of Q_4 (from R_D) until Q_4 gets out of saturation. Any further increase in rf amplitude reduces the current through D_1 and D_2 , which reduces the gain. R_D adjusts the point where Q_4 gets unsaturated and thus sets the rf level.

A variable capacitance diode (varactor) is used to adjust the frequency of the oscillator. The bias for this diode is varied by a potentiometer mounted on the panel. A digital read-out indicates frequency increments of 1×10^{-10} per digit. The total range of this electronic tuning is 2700×10^{-10} . Careful investigation has shown no measurable aging due to the varactor. The series resistance of the varactor used is negli-

gible compared with the resistance of the crystal. Excellent linearity of tuning is ensured by a variable load on the arm of the potentiometer (a second resistance element on the same shaft). See Figure 14. The linearity of this arrangement is typically better than $\pm 7 \times 10^{-10}$ (out of 2700×10^{-10}) or about $\pm 0.25\%$. Figure 15 shows a typical curve for the tracking error. The resolution of the potentiometer is such that the oscillator can be adjusted to within 2×10^{-11} of any frequency inside the range.

The advantages of electronic tuning are obvious. The varactors are small and do not require a shaft through the oven wall as is required for mechanically varied capacitors.

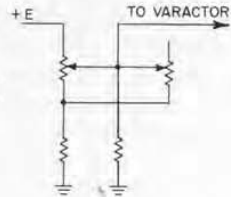

Figure 14. Linearizing network for varactor.

In addition, the use of varactor tuning permits control of frequency, by dc voltage, from a remote location and phase-locking of the oscillator by means of an external phase detector. External control voltage can be applied through a connector on the rear skirt of the instrument. Sensitivity is of the order of

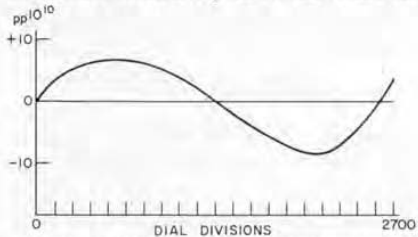

Figure 15. Tracking error of varactor tuning.



Figure 16. View of the investment casting in which the crystal and its associated circuit elements are mounted.

1.5 millivolts for a frequency change of 1×10^{-10} .

OVEN

A single-stage oven with proportional control holds the temperature of critical components within less than 10 millidegrees C. Power consumption of this oven was considered important because of battery operation in case of line failure. The power consumption is only about 500 milliwatts for operation at room temperature. The insulation of the oven is a combination of a Dewar flask and polyurethane foam, in which the flask is completely embedded. This assembly has survived shock tests of 50 g's, 11 msec, in any direction (MIL STD 202 Method 205 Condition C). The oven chamber is a copper investment casting (Figure 16). Plug-in circuit boards provide easy access to components.

EMERGENCY POWER

A nickel cadmium battery of 4 ampere-hours is floated across the dc supply. The cells of this battery are of the pressure-relief type and cannot explode. In case of power-line failure, operation

for 35 hours is ensured at room temperature and up to 24 hours at 0°C. An external dc supply of 22 to 35 volts can also be used. If ac power, external dc, and internal battery are connected, the power will be drawn from the source that provides the highest voltage to the regulator circuit. The change-over is made by diodes and is completely continuous.

The battery is recharged by a current-limited voltage source. As long as the battery voltage is significantly lower than the float voltage, the limit current flows. As the cut-off voltage is approached, the current rapidly decreases. This method ensures rapid recharging after power failure and maintains the battery at optimum charge conditions. The float, or trickle-charge, voltage is temperature compensated to vary approximately -2 millivolts per degree C per cell to correct for changes in the emf of the battery over the full temperature range.

PERFORMANCE

Aging

Typical aging rates are a few parts in 10^{10} per day after 30 days of operation and are down to about 1 in 10^{10} per day after 12 months.

Short-Term Stability

Figure 18 is a block diagram of the measuring system used. The 5-Mc outputs of the oscillators are multiplied 2000 times each (effectively to X-band),

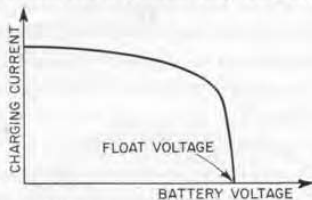

Figure 17. Battery recharge characteristic.

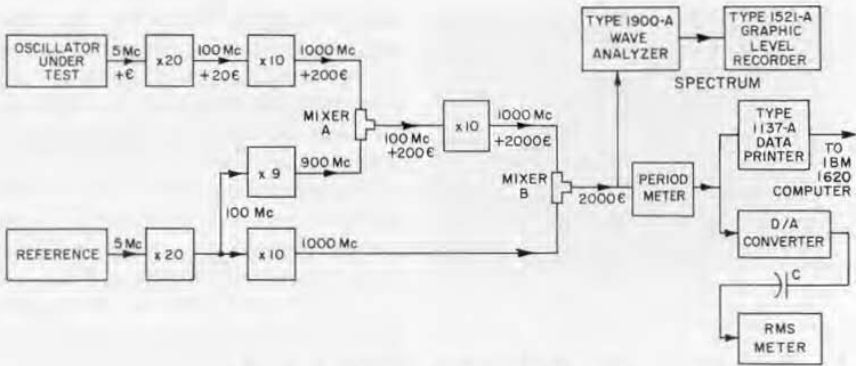

Figure 18. Block diagram of measuring system.

and the period of the beat note is measured by digital techniques. The result is processed by an IBM 1620 computer to obtain statistical data. For short averaging times (less than 10 milliseconds) the rms deviation is also measured directly by data converted from digital to analog form, which is fed into an rms meter. This meter is ac coupled and responds only to the deviations from the mean. The deviation indicated by this meter agrees to better than 10% with the data from the computer.

Figure 19 shows the data for one-second averaging time as they are produced by the computer. The data were taken at a time when Serial No. 154 was still aging rapidly (a few days after initial turn-on), and a large amount of drift is noticeable. This drift was then removed from the data. The results are in parts in 10^{15} for the mean and for sigma. The skew factor and the peak factor are parameters that provide an estimate of how nearly normal the distribution is. The skew factor is 0 and the peak factor 3.0 for a perfectly normal distribution. The maximum sigma at 95% confidence is for two os-

cillators compared with each other and, to obtain the sigma for one oscillator, should be divided by $\sqrt{2}$. The maximum sigma for one oscillator is 4×10^{-12} . Data for other averaging times are listed in Table I and plotted in Figure 20. The increase of deviation from one-second to 10-second averaging time is due to ambient temperature variation. The 10-second data were recorded over a 25-minute time interval. With

1115-9 XP VS 154 1 SEC SAMPLES 3/6/64	
DATA PARTS IN 10 TO THE 13TH	
PARAMETERS WITHOUT DRIFT CORRECTION	
SAMPLE SIZE	180
MAX X	953
MIN X	228
RANGE	725
MEAN	612.9000
STD ERROR OF MEAN	14.5531
SIGMA	195.2506
STD ERROR OF SIGMA	10.2906
SKEW FACTOR	-.3281
PEAK FACTOR	2.0545
MAX SIGMA AT .95 CONFIDENCE	212.1787
DRIFT PER 100 INTERVALS	361.1428
PARAMETERS CORRECTED FOR DRIFT	
MEAN	612.8995
STD ERROR OF MEAN	3.8826
SIGMA	52.0911
STD ERROR OF SIGMA	2.7454
SKEW FACTOR	.2408
PEAK FACTOR	2.6498
MAX SIGMA AT .95 CONFIDENCE	56.6074

Figure 19.

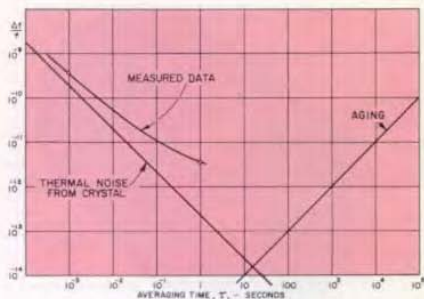

Figure 20. Measured data.

a typical temperature coefficient of $5 \times 10^{-12}/^{\circ}\text{C}$, it is obvious that temperature fluctuations of a fraction of a degree account for this increase. Also shown is the theoretical stability resulting from the thermal noise of the crystal resistance, as calculated from formula (3) on page 2.

Phase deviation can be computed from the frequency deviation by means of equation (10).

For 5 Mc,

$$\frac{\Delta f}{f} = 4 \times 10^{-12} \text{ and } \tau = \text{one second.}$$

$$\Delta \phi = 125 \times 10^{-6} \text{ radians.}$$

TABLE I SHORT-TERM STABILITIES

Sigma at 95% confidence

Averaging Time	Sigma
10 sec	5.5×10^{-12}
1 sec	4×10^{-12}
0.1 sec	1×10^{-11}
10 msec	7.3×10^{-11}
1 msec	39×10^{-11}
300 μsec	80×10^{-11}

SPECTRAL PURITY

The measuring system shown in Figure 18 was also used to obtain spectrum data. The beat frequency between the two oscillators, multiplied 2000 times, is analyzed with a TYPE 1900-A Wave Analyzer, set for 10-cycle bandwidth, and recorded with a Type 1521 Graphic

Level Recorder. The exceptional dynamic range of this combination makes it possible to present the spectrum in a particularly useful form. The oscillators are adjusted to have a beat frequency of about 3 kc (3000×10^{-10}). Figure 21 is a spectrum obtained by this method. The first visible sidebands appear about 45 db down from the main line, and the noise pedestal is 70 db down. There are no distinct sidebands visible. As this spectrum was taken after multiplication to the equivalent of X-band, it follows from formula (11) from page 8 that this corresponds to -111 db for the first visible noise near the main line and to -136 db for the noise pedestal, referred to the 5-Mc output of the oscillator. For one oscillator, another 3 db should be subtracted; 10 db should be subtracted to refer the noise to 1-cycle bandwidth. The two numbers are -124 db/√cps for the noise near the main line and about -149 db/√cps for the noise pedestal.

Sometimes a figure is given for line "width." This is, of course, strictly a colloquialism, as a line cannot have any width. What is meant is: how far from the carrier are the sidebands 3 db down? Figure 22 shows the center part of the

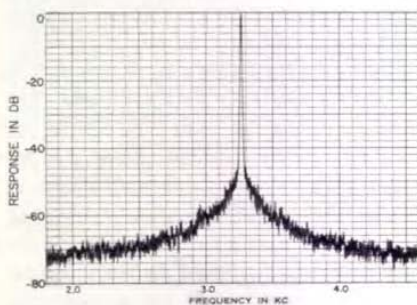

Figure 21. X-band power spectrum of two Type 1115-B Standard-Frequency Oscillators. Analyzer bandwidth is 10 cps.





spectrum plotted with an analyzer bandwidth of 0.54 cps (by use of a special analyzer filter), and Figure 23 shows the response of the filter. As Figure 22 shows no broadening of the response of the filter, it can be stated that the line "width" is less than 0.25 cps at X-band.

OTHER FACTORS AFFECTING THE FREQUENCY

Temperature

Temperature control of the crystal and other critical components keeps the over-all temperature coefficient typically less than $5 \times 10^{-12}/^{\circ}\text{C}$. Transient response is such that frequency excursions stay within the specified steady-state limits for sudden changes in temperature over the range of 0 to 50°C .

Load

Loading effects have been reduced to negligible amounts by careful arrangement of ground loops. Very little output is fed back into the oscillator, as evidenced by the fact that tuning of the output circuit does not affect the frequency to any measurable extent, i.e., less than 2×10^{-11} . In addition to resistive loads, reactive loads can be tolerated. A reactive load of 50 ohms (620 pf) causes, typically, 3×10^{-11} frequency shift.

Vibration

The only component significantly affected by vibration is the crystal unit. The acceleration coefficient is about 1 to 1.3×10^{-9} per g in the most sensitive direction, and, for low frequencies, there is little reduction of vibration from the instrument frame to the crystals. As the frequency is raised, some attenuation is afforded by the foam insulation of the oven.

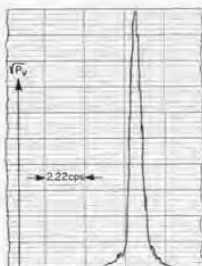

Figure 22. Center portion of spectrum of Figure 21, measured with 0.54-cycle bandwidth. Vertical scale is linear ($\sqrt{\text{power}}$).

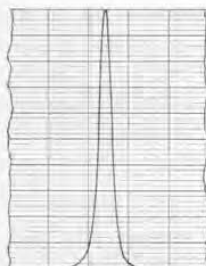

Figure 23. Analyzer passband characteristic used for spectrum of Figure 22.

Power-Supply

Power-supply changes have little effect on frequency. The frequency does not change more than $\pm 1.5 \times 10^{-11}$ for any safe operating condition of ac or dc supply voltage or for the range of voltages from a fully charged to a completely discharged internal battery.

MONITOR CIRCUITS

A single meter is used to monitor the 5-Mc, 1-Mc, and 100-ke output levels, oven temperature, oven heater voltage, dc supply voltage, and battery current. In all functions, clearly marked sectors on the meter indicate the ranges for normal operation.

GENERAL

The instrument uses all-silicon, solid-state circuitry. All components are of high quality, consistent with the requirements of long continuous service. All electrolytic capacitors are tantalum except for the ac power-supply filter capacitor, which is a Mil-grade aluminum electrolytic. All etched circuits use Fiberglass-epoxy boards. The rugged, mechanical construction will withstand abuse during shipment and the mobile-



service environment. The instruments meet the requirements of MIL STD 167 for vibration and will withstand 30-g shocks of 11-msec duration in any direction.

— H. P. STRATEMEYER

SPECIFICATIONS

OUTPUT

Frequencies: 5 Mc, 1 Mc, 100 kc.

Frequency Adjustment: 2700×10^{-10} (1×10^{-10} per dial division). Can also be varied by external voltage.

Voltage: 1 volt, rms, $\pm 50\%$ into 50 ohms at each frequency.

Spectral Line Width: < 0.25 cps at 10 Gc.

FREQUENCY STABILITY

Short Term: Standard Deviation (sigma) is less than stated below (95% confidence):

Averaging Time	Sigma
0.3 msec	100×10^{-11}
1 msec	50×10^{-11}
10 msec	10×10^{-11}
0.1 sec	1.5×10^{-11}
1 sec	1.0×10^{-11}
10 sec	1.0×10^{-11}

Aging: $< 5 \times 10^{-10}$ per day after 30 days;
 $< 1 \times 10^{-10}$ per day is typical after one year.

Type		Price
1115-BM	Standard-Frequency Oscillator, Bench Model	\$2,050.00
1115-BR	Standard-Frequency Oscillator, Rack Model	\$2,050.00

PAPERS SOUGHT FOR CONFERENCE ON AUTOMOTIVE ELECTRICAL AND ELECTRONICS ENGINEERING

Original papers covering the forefront of the art are sought for the First National Conference on Automotive Electrical and Electronics Engineering to be held September 22 and 23 in Detroit, at the McGregor Memorial Center of Wayne State University.

Within the context of automobiles and traffic, the following subject categories will be considered:

1. Systems and Automatic Control
2. Communication and Signalling
3. Vehicle Propulsion and Control
4. Energy Storage and Conversion
5. Sensors and Gauges
6. Components and Devices
7. Test Instrumentation
8. Manufacturing Processes and Techniques
9. Electronics in Sales and Distribution

CREDITS

The author wishes to acknowledge the many contributions made by others in the design of this instrument and, in particular, the assistance of W. J. Riley in development, G. E. Neagle for the mechanical design, and W. N. Tuttle for writing the program for the computer for statistical evaluation of short-term stability.

Temperature: $< 5 \times 10^{-10}$ from 0 to 50 C.

Load: $< \pm 2 \times 10^{-11}$ from open circuit to short circuit.

Supply Voltage: $< \pm 2 \times 10^{-11}$ from 22 to 30 volts, dc; $< \pm 1 \times 10^{-11}$ for $\pm 10\%$ ac line-voltage changes.

POWER REQUIREMENTS (AC or DC)

AC: 90 to 130 (or 180 to 260) volts, 40 to 2000 cps, 8 watts at 115 volts.

DC: 22 to 35 volts; 4 watts at 24 volts.

Emergency: Internal battery, 24-35 hours, depending on ambient temperature.

GENERAL

Construction: Ruggedized; rack-bench cabinet.

Dimensions: Bench model — width 19, height $5\frac{1}{4}$, depth $14\frac{1}{2}$ inches (485 by 135 by 370 mm), over-all; rack model — panel 19 by $5\frac{1}{4}$ inches (485 by 135 mm); depth behind panel $12\frac{1}{2}$ inches.

Net Weight: 35 pounds (16 kg).

Shipping Weight: 39 pounds (18 kg).

Each prospective author should submit an abstract (500 to 1000 words) not later than July 15th to the Chairman of the Papers Committee, Mr. E. A. Hanyasz, General Motors Research Laboratories, G. M. Tech. Center, Warren, Michigan. The author should indicate the length of time required for presenting and discussing the paper. This length may be as short as 10 minutes or less, but should definitely not exceed 30 minutes.

The Conference is sponsored by Southeastern Michigan Section and PTC-IECI of IEEE, University of Michigan, Michigan State University, Wayne State University, and University of Detroit.

General Chairman is Ole K. Nilssen, Applied Research Office, Ford Motor Company, Dearborn, Michigan.



CONVENIENT GENERATOR-DETECTOR UNIT FOR BRIDGE MEASUREMENTS

The TYPE 1232-A Tuned Amplifier and Null Detector¹ and the TYPE 1311-A Audio Oscillator² have been combined in a single, convenient unit for use with audio-frequency bridges and other null-balance devices. This new assembly, the TYPE 1240-A Bridge Oscillator-Detector, occupies a minimum of bench space and is provided with removable panel extensions, which adapt it for rack mounting. The combination can also be easily disassembled so that component instruments can be used separately.

The oscillator supplies 11 fixed frequencies from 50 cps to 10 kc. The

detector is tunable continuously from 20 cps to 20 kc, with additional spot frequencies of 50 kc and 100 kc.

¹ A. E. Sanderson, "A Tuned Amplifier and Null Detector with One-Microvolt Sensitivity," *General Radio Experimenter*, 35, 7, July 1961.

² R. G. Fulks, "High Performance, Low-Cost Audio Oscillator with Solid-State Circuitry," *General Radio Experimenter*, 36, 8 and 9, August-September 1962.

SPECIFICATIONS

Dimensions: Width 19, height 6, depth 7¾ inches (485 by 155 by 200 mm), over-all.

Net Weight: 13½ pounds (6.5 kg).

Shipping Weight: 28 pounds (13 kg).

<i>Type</i>	<i>Price</i>
1240-A Bridge Oscillator-Detector	\$565.00



Panel view of the Bridge Oscillator-Detector Assembly.



Panel view with panel extensions attached for relay-rack mounting.

BRIDGE ASSEMBLY FOR PRECISION INDUCTANCE MEASUREMENT

For the precise measurement of inductance and the intercomparison of inductance standards, the TYPE 1632-A Inductance Bridge¹ offers both accuracy and convenience. Its wide range of inductance, from 0.0001 μh to 1111 h, embraces a variety of applications. It can measure rf coils at 1 kc (where stray capacitance is not a factor) to an accuracy of 0.1%. It can compare two 10-henry standard inductors at 100 cps to a precision of 1 part in 10⁵.



Panel view of the Inductance Measuring Assembly.





Although designed primarily for measurements at 1 kc and lower frequencies, it is usable, with little impairment in accuracy, up to 10 kc.

This bridge is now available in combination with the TYPE 1240-A Bridge Oscillator-Detector² as the TYPE

1660-A Inductance Measuring Assembly.

SPECIFICATIONS

Dimensions: Width 19½, height 23, depth 10½ inches (495 by 590 by 270 mm), over-all.

Net Weight: 62 pounds (29 kg).

Shipping Weight: 92 pounds (42 kg).

¹J. F. Hersh, "A Bridge for the Precise Measurement of Inductance," *General Radio Experimenter*, 34, 11, November 1959.

²See page 17.

Type		Price
1660-A	Inductance Measuring Assembly	\$1555.00

INEXPENSIVE VARIAC® AUTOTRANSFORMER LIGHTING CONTROL

By Fred B. Otto

The control board described here was designed and built by the author in order that the eight Variac® autotransformers, obtained by the Mansfield Players over the past several years, could be operated with the convenience and versatility of a lever action and a mechanical master found in professional boards. Because the operator can hold several levers in each hand and can also master them to a single lever, he can easily carry out operations that are impossible with knobs. Since, like many other amateur theatrical groups, the Mansfield Players are challenged by a budget that is practically nonexistent, the board was designed to use materials that are inexpensive and readily available.

The autotransformers were mounted

in two rows to conserve space and to bring the handles closer together. Eight 3-inch V-belt pulleys were then mounted on a ½-inch shaft, which was mounted in two holes in the box. A 1½-inch pulley was used as a mounting for the master handle. Since it was found that a setscrew was not sufficient to keep this pulley from slipping when all eight dimmers were mastered, a hole was drilled through the pulley and shaft, and a cotter pin inserted. The spacing between pulleys was maintained by short pieces of pipe cut to length and slipped over the shaft. A smooth pipe was mounted near the first row of autotransformers, as shown in Figure 1, to guide the cord.

The connection between the V-belt pulley and the autotransformer shaft was made by means of a piece of heavy Venetian-blind cord. The cord was secured to the shaft of the Variac by means of a machine screw worked through the cord and into a hole that had been drilled and tapped in the side of the shaft about ½ inch from the end. The cord was given one and a half turns around the shaft of the Variac and then was tied to the V-belt pulley

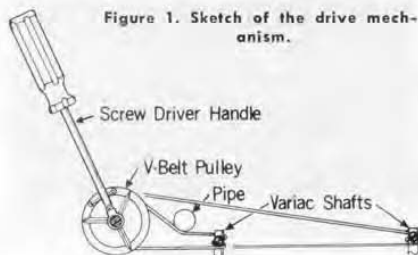

Figure 1. Sketch of the drive mechanism.

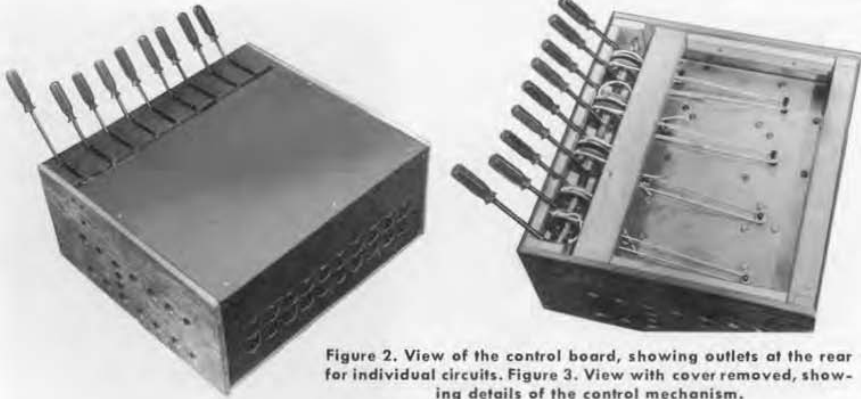

Figure 2. View of the control board, showing outlets at the rear for individual circuits. Figure 3. View with cover removed, showing details of the control mechanism.

by means of two holes drilled in its flange. Though it was found sufficient to wrap the cord around the shaft of each TYPE W5 Variac autotransformer, it would probably be necessary to use a small thread spool on the shafts of the higher power TYPE W10 and TYPE W20 Variac autotransformers and to use a correspondingly larger pulley.

Inexpensive screwdrivers with $\frac{5}{16}$ -inch-diameter shafts were used for handles. The shafts were heated to remove the temper, the tips cut off, and the shafts threaded to fit the $\frac{5}{16}$ -inch setscrew holes of the pulleys.

The difference in diameter between the pulley and the autotransformer shaft causes the Variac to turn the full 320° when the lever is moved through about 90° . Mastering is accomplished by a simple twist of the handle in the setscrew hole so that it tightens against the shaft, causing the pulley to turn with the shaft. It should be noted that with this arrangement dimmers can be mastered at different points so that some dimmers can be maintained several points above or below the rest during fades. The 2-inch spacing of the handles was chosen to be large enough

for them to be held separately, and yet to be as small as possible so that the maximum number of handles could be moved at once.

This board with its low cost, light weight, and high degree of controllability has proved to be well suited to our needs and may well be equally suited to the needs of other groups.

Mr. Fred B. Otto, who designed and built this control board for the Mansfield Players, is a graduate of the University of Maine, at present studying for his Ph.D. in physics at the University of Connecticut. In addition to his association with the Mansfield Players, he has also worked with the Maine Masque Theater and the Parish Players of Winchester, Massachusetts.



Figure 4. The author at the controls.



Melville Eastham

1885 — 1964



Melville Eastham, founder of General Radio Company and its president from 1915 to 1944, died on May 7. His professional and business career spanned the growth of electronic engineering from its beginnings as wireless telegraphy to the present and was marked by important contributions to science, industry, and national defense.

He was born in Oregon City, Oregon, June 26, 1885, and was educated in the Oregon public schools. He moved to Boston in 1906 as a cofounder of Clapp-Eastham Company, a manufacturer of radio receiving and transmitting equipment. In 1915 he founded General Radio Company.

He was a Fellow of the Institute of Electrical and Electronics Engineers and of the American Association for the Advancement of Science, and a member of the Acoustical Society of America, the American Physical Society, and the American Meteorological Society. In 1945 he was awarded the honorary degree of Doctor of Engineering by Oregon State College.

As one of the leaders of the Office of Scientific Research and Development, he was instrumental in marshalling the electronic-engineering effort during World War II, and played

a principal role in the development of the Loran navigational guidance system.

Mr. Eastham was responsible for many important electrical standards, components, and construction techniques. Widely recognized as a pioneer in progressive employer-employee relations, he initiated in the early days of General Radio many employee benefits that were later widely adopted in industry. Largely through his technical guidance and his humanitarian approach to corporate management, General Radio was able to grow to a prominent position in the electronics industry while preserving its unusual system of self-ownership.

Melville Eastham's many friends in the electronics industry may wish to know that a fund in his memory has been established for the general purposes of the Massachusetts Institute of Technology. Contributions may be sent to the Melville Eastham Memorial Fund, Massachusetts Institute of Technology, Cambridge, Massachusetts.

