



THE GENERAL RADIO

Experimenter

Frequency Synthesizers

Frequency-Stability Measurements
Phase Noise
Sweep and Marker Generator
Delay-Line Measurements

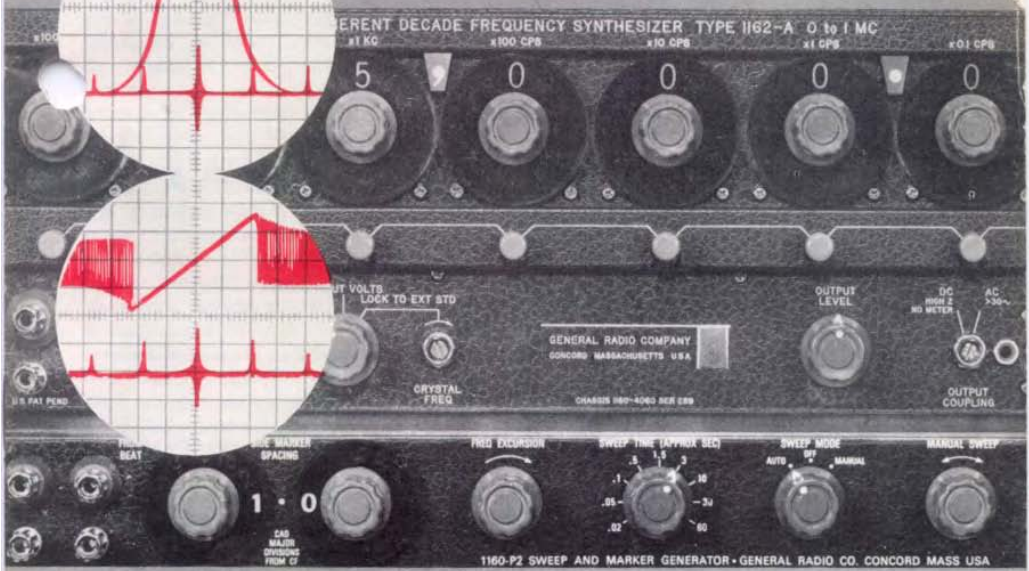
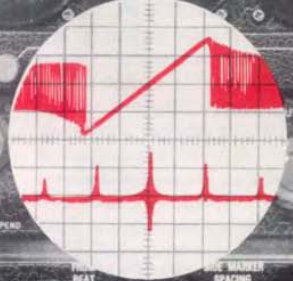
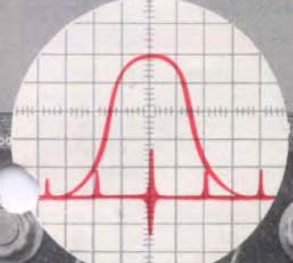
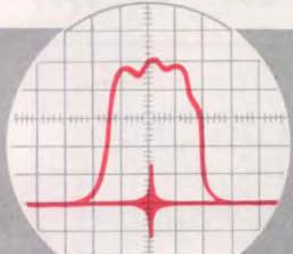

VOLUME 41 • NUMBER 1 / JANUARY 1967



IET LABS, INC in the GenRad tradition
534 Main Street, Westbury, NY 11590

www.ietlabs.com
TEL: (516) 334-5959 • (800) 899-8438 • FAX: (516) 334-5988

the Experimenter

© 1967 — General Radio Company, West Concord, Mass., USA

Published monthly by the General Radio Company

THIS ISSUE

	Page
The Use of Frequency Synthesizers for Precision Measurements of Frequency	
Stability and Phase Noise	3
Phase Noise in 1160-Series Frequency Synthesizers.....	11
A Sweeper for GR Synthesizers.....	15
The Synthesizer in the Production Testing of Precision Delay Lines.....	22

GENERAL RADIO COMPANY West Concord, Massachusetts 01781

* NEW ENGLAND
22 Baker Avenue
West Concord, Massachusetts 01781

* METROPOLITAN NEW YORK
Broad Avenue at Linden
Ridgefield, New Jersey 07657

PHILADELPHIA
Fort Washington Industrial Park
Fort Washington, Pennsylvania 19034

* WASHINGTON and BALTIMORE
Post Office Box 1160
11420 Rockville Pike
Rockville, Maryland 20850

ORLANDO
113 East Colonial Drive
Orlando, Florida 32801

SYRACUSE
Pickard Building, East Molloy Rd.
Syracuse, New York 13211

CLEVELAND
5579 Pearl Road
Cleveland, Ohio 44129

* CHICAGO
6605 West North Avenue
Oak Park, Illinois 60302

* DALLAS
2600 Stemmons Freeway, Suite 210
Dallas, Texas 75207

* LOS ANGELES
1000 North Seward Street
Los Angeles, California 90038

SAN FRANCISCO
Post Office Box 1389
526 San Antonio Road
Mountain View, California 94040

MONTREAL
1255 Laird Boulevard
Town of Mt. Royal, Quebec, Canada

* TORONTO
99 Floral Parkway
Toronto 15, Ontario, Canada

* Repair services are available at these offices

GENERAL RADIO COMPANY (OVERSEAS), 8008 Zurich, Switzerland

GENERAL RADIO COMPANY (U.K.) LIMITED, Bourne End, Buckinghamshire, England

REPRESENTATIVES IN PRINCIPAL OVERSEAS COUNTRIES



IET LABS, INC in the GenRad tradition
534 Main Street, Westbury, NY 11590

www.ietlabs.com
TEL: (516) 334-5959 • (800) 899-8438 • FAX: (516) 334-5988

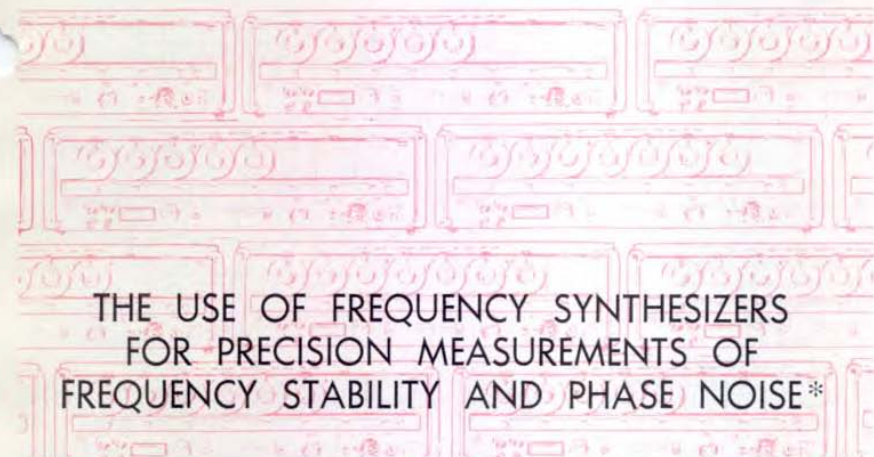

THE USE OF FREQUENCY SYNTHESIZERS FOR PRECISION MEASUREMENTS OF FREQUENCY STABILITY AND PHASE NOISE*

Few new instruments have been accepted as quickly and as widely as has the frequency synthesizer, and few have prompted so many inquiries about their characteristics and capabilities. This month's *Experimenter* responds to the growing interest in synthesizers with four articles: In the first, Dr. Atherton Noyes, who directs GR's synthesizer development, tells how synthesizers can be used to measure the frequency stability and phase noise of other frequency sources. This is followed by a discussion of the phase noise of the synthesizer itself. A new sweep and marker generator for the synthesizer is described in the third article. Finally, the synthesizer is seen solving a problem in production-line testing — the precise, direct measurement of the delay of a solid ultrasonic delay line.

The 1160-series frequency synthesizers, in addition to serving as versatile frequency sources, can be used to track and to record frequency variations in other frequency sources.¹ This is so because the frequency of the continuously adjustable decade (CAD) can be smoothly controlled manually and elec-

trically. By making use of this capability one can maintain exact equality between the frequency under investigation and an adjustable and precisely known standard.

Precision measurements of frequency by establishment of approximate equality between an unknown and a fixed standard and observation of variations in the beat frequency between them have been common practice for many years. For high-precision comparisons, the beat frequency is usually measured in terms of rate of change of phase, over minutes or hours.

The task of measuring phase drift between a *fixed*-frequency standard and an unknown frequency and translating it into frequency error is laborious, and the results often yield only an average over a relatively long time interval. A synthesizer, on the other hand, provides a highly precise standard frequency that can be continuously adjusted to

* Much of the material in this paper was presented at the 21st Annual ISA Conference in New York on October 27, 1966.

¹ Atherton Noyes, Jr., "Coherent Decade Frequency Synthesizers," *General Radio Experimenter*, September 1964, page 11.

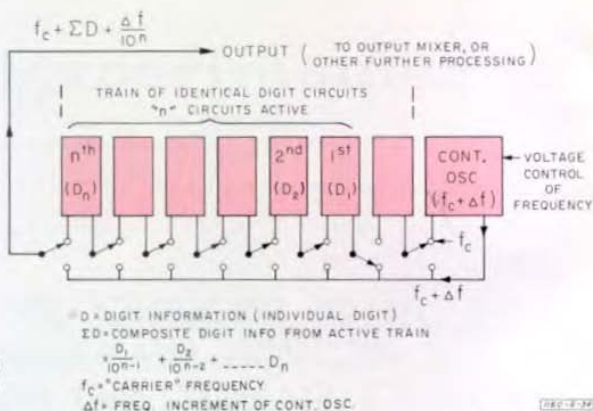

Figure 1. Simplified block diagram of a General Radio frequency synthesizer

maintain an exact, zero-beat match with an unknown. For manual control, a Lissajous figure on an oscilloscope is a convenient indication of exact zero beat (zero rate of change of phase). A frequency difference of only a millihertz, for example, is apparent within a few seconds of observation.

However, it is usually easier to compare the two signals in a phase detector that, for a phase difference of 90°, produces a dc output of zero volts (on which are superimposed the effects of random phase fluctuations — "phase noise" — in both of the compared signals). An unchanging dc component of the phase-detector output indicates that the frequencies are equal; also, any ac components indicate phase noise directly.

By using a voltage-tunable frequency synthesizer one can set up a closed-servo-loop frequency control to maintain zero frequency difference in the presence of drifts and fluctuations of the signal under examination. Most suitable for such applications is a synthesizer that, like the GR 1160-series, uses a series of repetitive circuit modules to synthesize an output frequency

to any desired fineness of resolution, and that includes a continuously adjustable voltage-controlled oscillator which can replace a step digit unit at any chosen rank.

Figure 1 is a simplified block diagram of such a synthesizer. Each digit unit processes the signal passing through the train in such a way as to reduce by a factor of 10 any frequency variation occurring in its input signal. So, if the continuous oscillator feeds the first of, say, seven digit units, the variation in output frequency from the train is only $\frac{1}{10^7}$ the variation in the starting signal from the continuous oscillator. A change of 100 Hz in the oscillator thus produces a change of only 100×10^{-7} Hz, or 10 microhertz, at the output.

Conversely, if the synthesizer is constrained to adjust its output frequency smoothly to maintain exact equality with a second, perhaps slightly unstable, frequency by variation of the continuous oscillator, then a drift of only 10 microhertz in the unknown will produce a 100-Hz change in the continuous oscillator.

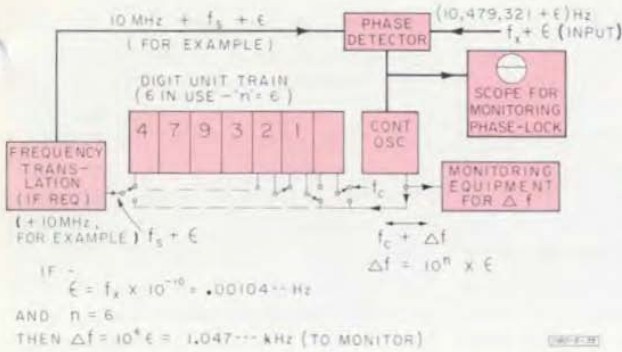

Figure 2. Block diagram illustrating frequency-tracking scheme. ϵ represents any small frequency drift of the unknown, which is matched and canceled by the servo loop.

Since the total tuning range of the continuous oscillator used in such a system is always the same, no matter which decade the oscillator replaces, simple switching allows selection of the proper magnification for the task at hand. Circuits for monitoring the continuous oscillator are not affected by such switching.

Figure 2 is a diagram illustrating frequency tracking by this technique. The unknown frequency f_x and the synthesized output are here maintained equal in frequency by the phase-lock loop, which includes the voltage-controlled oscillator (VCO) at the start of the synthesizer train. Resulting frequency changes in the VCO are monitored as shown. Note that a change of 1 part in 10^{10} in f_x (1.04 --- millihertz)

produces a very easily measured change of 1.04 --- kHz in the VCO frequency, in the example illustrated here. In this example, the standard frequency is offset by a fixed frequency of 10 MHz. Such frequency translation is sometimes useful for achieving a frequency match at frequencies outside the band of the synthesizer, or for obtaining higher resolution with the available number of digits in the synthesizer.

There are obviously a great many ways in which Δf of the VCO can be measured or recorded. The method we have used at GR is diagrammed in Figure 3. This setup makes use of the fact that, in the 1160 series of GR synthesizers, internal circuits compare the output frequency of the CAD (Continuously Adjustable Decade) with

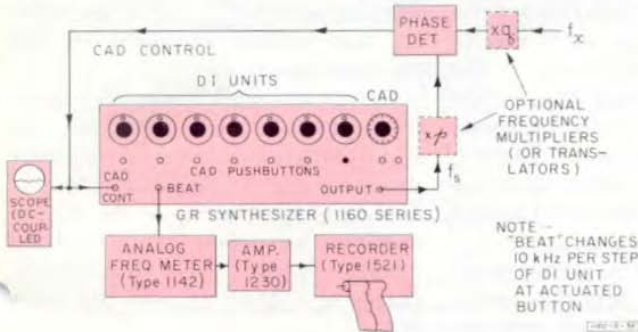

Figure 3. Block diagram illustrating the use of the internal frequency-comparison circuits.

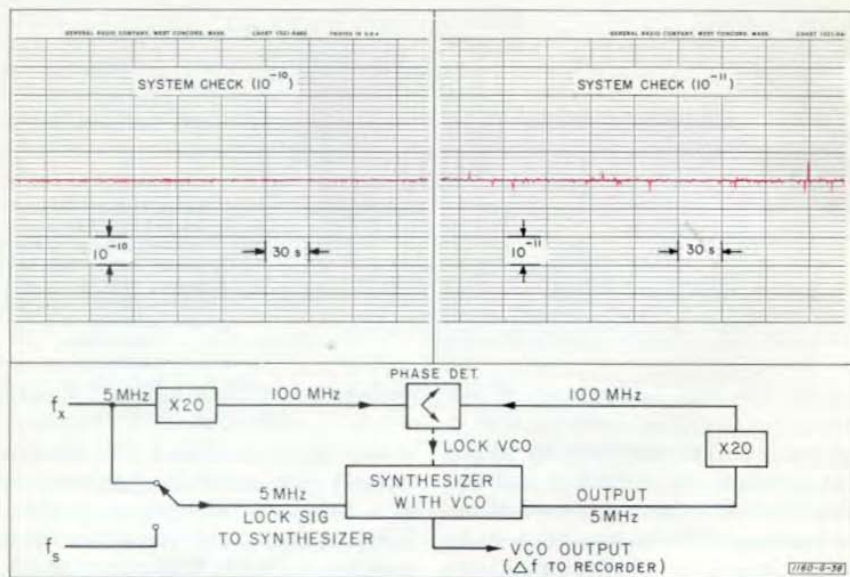

Figure 4. Recordings to check system. Synthesizer lock signal and unknown signal are identical.

the frequency generated by the digit-insertion units that it functionally replaces by push-button selection, and the resulting beat-note is available at the BEAT terminals.¹ The CAD frequency can be tuned manually and can be voltage-controlled about the manual setting. If the frequency of the CAD exactly matches that of the replaced digit units, the BEAT output frequency is zero. If the setting of the digit unit at the actuated button is then changed one step, the beat signal changes by exactly 10 kHz. (There is no change in the main output frequency.) This feature permits establishment of a convenient reference-offset to give sense information about frequency drifts, while the phase detector maintains exact equality of the compared signals.

The analog frequency meter shown in Figure 3, together with the graphic level recorder, can be adjusted for

center-of-chart pen positions when the input to the frequency meter is 10 kHz. Hence, positive or negative frequency drifts of f_x are unambiguously traced on the recorder chart, with the chart center line exactly corresponding to the dialed synthesizer frequency. The scale factor of the recording can be changed in decade steps by actuation of the synthesizer pushbuttons and in smaller amounts by adjustments of the recorder sensitivity. Frequency shifts are also visually displayed by the frequency meter.

Figures 4 through 8 show illustrative recordings. For these recordings, the 5-MHz synthesized standard frequency was taken directly from the output of the digit-unit train (via the output amplifier, by means of an internal jumper change). This translational change of 5 MHz provides one extra

¹ *Ibid.*

digit of resolution and a somewhat lower-noise signal than is available directly from higher-frequency synthesizers.

Figure 4 shows a system check. The frequency used as the standard to phase-lock the synthesizer is also connected to the f_x input. Ideally, the recording should be an undisturbed straight line at $\Delta f/f = 0$. Actually, occasional small phase jumps occurring in the synthesized channel produced uncorrelated disturbances recorded as a few parts in 10^{12} .

For each recording of Figure 5, two separate precision oscillators were used, one to phase-lock the synthesizer and the other as f_x . The lock signal f_s was provided by the General Radio Bolton Plant standard, by way of the plant distribution system. For the left-hand trace, a typical 1115-B Oscillator was

used as f_x and recorded against this standard. In the right-hand trace, a somewhat less stable oscillator supplied f_x . The difference in short-term behavior is quite apparent. Note that for both traces one major division represents 1 part in 10^{11} . The time scale is 30 seconds per division.

For the recordings of Figures 4 and 5, the recording bandwidth was enhanced by frequency multiplication of both channels to 100 MHz before the phase detector. By this process the phase-lock bandwidth was increased to $\pm 1/4$ Hz, at a sensitivity of 10^{-11} per division, and to ten times this, or $\pm 2 1/2$ Hz, at 10^{-10} . (To measure lock bandwidth, the manual tuning control of the CAD was moved to the high and low limits of the lock range, as indicated by the phase-detector monitor. This CAD dial range, multiplied by the

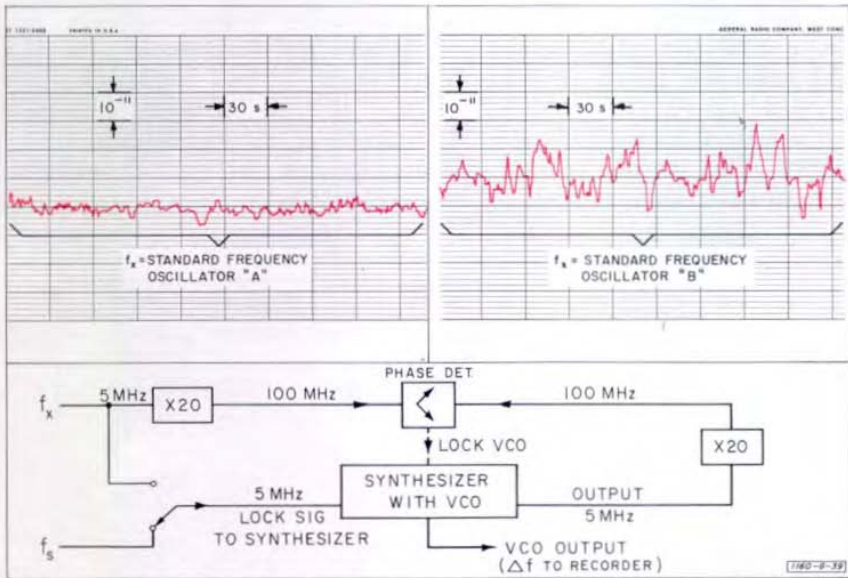

Figure 5. Frequency-comparison recordings of two oscillators relative to a standard used to lock the synthesizer.

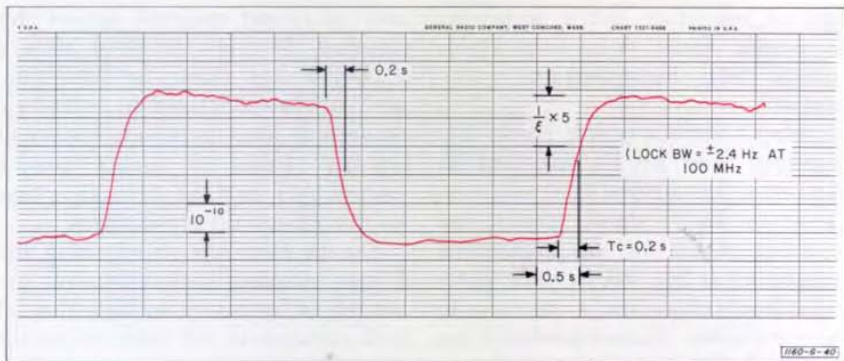

Figure 6. System-bandwidth recording, showing response to abrupt frequency steps of about 5×10^{-10} .

Hz/step at the CAD functional position, gave bandwidth directly.)

Figure 6 shows the response of the system, at 10^{-10} per division sensitivity, to abrupt f_x steps of about 5×10^{-10} . A time constant of about 0.2 second is indicated, so that, at this sensitivity setting, fluctuations at frequencies from zero up to several hertz, as well as the longer-period drifts that are trackable with narrower bandwidths, can be recorded.

The system described indicates frequency shifts *directly*, rather than as a changing slope of phase versus

time as is customary in precision measurements. As a further example, Figure 7 shows immediately the frequency shifts that resulted when a precision oscillator was rotated 90° in the earth's gravitational field.

Figure 8 shows a less demanding measurement. The behavior of a simple, experimental crystal oscillator, subjected to ambient temperature changes, is shown at two sensitivities (10^{-8} and 10^{-9} per division). High-speed response at extreme resolution was not required, so the two $\times 20$ multipliers were not used.

Figure 7. Recording showing instantaneous frequency shifts (about 6 parts in 10^{10}) of a standard-frequency oscillator as it is repeatedly rotated 90° relative to the earth's gravitational field.

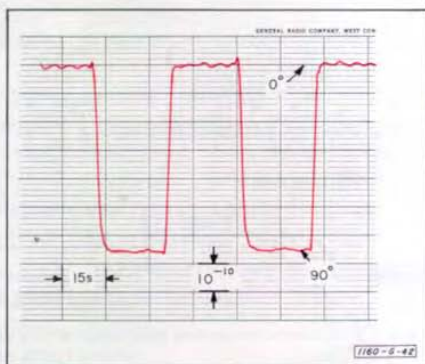

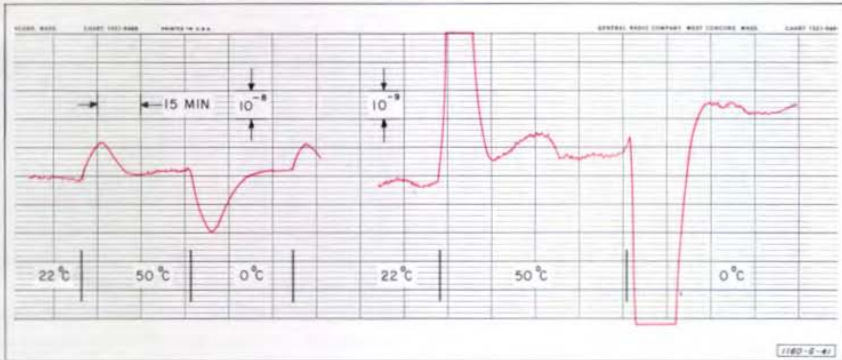

Figure 8. Recordings showing the response of a crystal oscillator as a function of temperature.

Use of the Setup for Phase-Noise Studies

This general setup is also useful for observing short-term fluctuations. The oscilloscope, which in Figure 3 was shown connected as a dc monitor of phase lock at the control-signal output of the phase detector, is also a useful indicator of high-frequency phase noise, at all frequencies outside the phase-lock bandwidth. Such frequencies are not degenerated by the phase lock and appear at the phase-detector output.

The oscilloscope, therefore, can supply quantitative information on phase jitter. The only function of the phase-lock, in this case, is to maintain f_s and f_x at a 90° phase relationship. One

should keep the loop bandwidth as low as is consistent with the stability of the oscillator under test, in order to avoid degenerating noise frequencies of interest. It is easy to calibrate the phase deviation, $\Delta\theta$, in terms of the peak value of a beat note created by frequency displacement of one of the inputs, as shown in Figure 9, at the left. If the oscilloscope gain is then increased, under centered phase-lock conditions, the height of the grass measures phase jitter, as illustrated in Figure 9, at the right. Suitable filters placed in the oscilloscope input can limit the noise bandwidth, as desired. For low-noise sources, frequency multi-

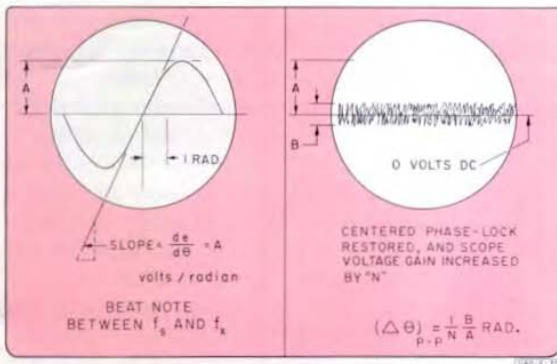

Figure 9. Oscilloscope calibration for phase noise.

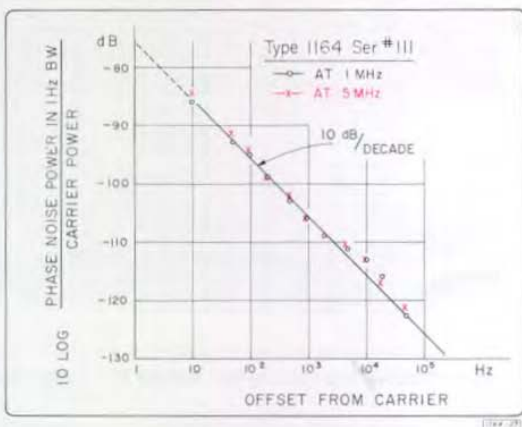

Figure 10. Single-side phase-noise power-density, referred to carrier.

plication before the phase detector (as previously described) is desirable, in order to magnify the noise prior to detection.

A high-gain selective voltmeter connected to the phase-detector output can be used to observe sideband noise distribution. Figure 10 shows a plot of phase-noise density, as a function of offset from signal, taken with a GR 1900 narrow-band wave analyzer. More details on this type of measurement are given in an accompanying article.²

CONCLUSION

Systems such as those described above can thus be used to observe and to record not only relatively long-term drifts over periods ranging from seconds to days but also shorter-period fluctuations at rates up to several hertz and, additionally, higher-frequency, noise-sideband power distribution.

The synthesizer, used as an error magnifier, can supply the total standard signal, either directly or with multiplication, or it can be inserted as an additive component, as circumstances dictate. For measurements of very high-

quality signals, translation by frequency addition is to be preferred, for two reasons: First, the added frequency component can perhaps have somewhat lower noise than the synthesized component, so that the composite signal may be significantly better than one obtained by straight multiplication; second, adding the synthesizer signal to a large fixed component will make available finer fractional resolution than the synthesizer has itself.

The techniques described above have become available with the advent of the synthesizer. Equally good, and perhaps better, results can be achieved by other methods. It is worth re-emphasizing, however, that the synthesizer method displays instantaneous variation of frequency, rather than of phase, that it does so with high magnification, and that it is not necessary to work at one of a limited number of standard frequencies, such as 1 MHz or 5 MHz. The synthesizer is nimble, and it can take the measure of any unknown, on its own ground.

— ATHERTON NOYES, JR.

²"Phase Noise in 1160-Series Frequency Synthesizers," this issue, page 11.

PHASE NOISE IN 1160-SERIES FREQUENCY SYNTHESIZERS

The quality of a sine-wave signal generated by an oscillator is usually degraded by the presence in the output of additional frequency components, which can be classified in the following groups:

(1) Harmonics of the desired frequency.

(2) Sidebands accompanying the desired frequency, created by modulation of the signal by power-line frequency components (60 Hz, 120 Hz, etc).

(3) Other nonharmonically related sideband components. (In frequency synthesizers, these are generally due to the heterodyning of high-order harmonics of signals applied to one or more of the synthesizer frequency mixers. Such harmonics are usually generated in the mixer itself. Spurious sidebands can also be created by signals leaking from one part of the circuit to another, owing to ground loops or imperfect shielding.)

(4) Sidebands created by random-noise modulation.

We have given much thought to the problem of how best to describe the quality of the signals generated by the 1160-series synthesizers, and we have concluded that it is sensible to separate discussion of the undesired sideband components by classes as listed above.

The single-frequency harmonic and nonharmonic "spurs" are most easily measured by means of a sharply selec-

tive receiver. This receiver may be of conventional type, such as the Hammarlund SP600; even better, it may consist of a wave analyzer, such as GR's TYPE 1900, used as a tunable i-f amplifier and output indicator, after an external mixer. For stability, the local oscillator of this composite receiver should be a synthesizer, preferably with its 5-MHz internal oscillator phase-locked to the synthesizer being tested. This technique, employing such a highly selective receiver, serves well to make the single-frequency measurements of harmonics, power-line-related sideband components, and nonharmonically related spurs (Classes 1, 2, and 3 above). Specifications on these have already been published in the *General Radio Catalog* and in the *Experimenter* (September 1964, November-December 1965, and September 1966).

The TYPE 1900 Wave Analyzer can also serve as a high-gain selective volt-



Atherton Noyes received his undergraduate and graduate degrees (AB, AM, SM, ScD) at Harvard University. From 1937 to 1960 he was on the engineering staff of Aircraft Radio Corporation. He has directed GR's frequency-synthesizer development since 1960, and he is currently the Group Leader of the Signal-Generator Group.

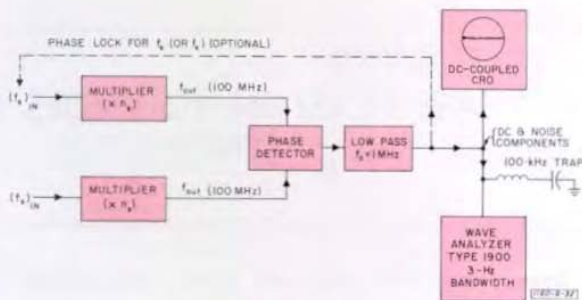

Figure 1. Equipment setup for the measurement of phase-noise density.

meter for measuring random-noise components at any chosen spacing from the carrier. Measurements made on representative groups of 1162, 1163, and 1164 synthesizers by this method are reported here. Figure 1 shows the experimental setup in block-diagram form. This is merely a variation of the selective receiver suggested above, in which the local-oscillator frequency and signal frequency are identical, and the tunable i-f amplifier and output indicator measures *both* sidebands corresponding to any component of frequency modulation of the signal. (The 100-kHz trap at the 1900 input ensures that any 100-kHz sidebands in the measured signal are not able to leak past the input circuits into the 100-kHz fixed-tuned amplifier of the Wave Analyzer in sufficient magnitude to affect the measurement.)

As shown in Figure 1, two precision frequencies are each multiplied to 100 MHz (to increase sensitivity, as explained below) and compared in a phase detector. When the two 100-MHz signals are in phase quadrature, the dc output of the phase detector is zero, and the noise in the phase-detector output is "phase noise" (i.e., phase jitter will produce an output; amplitude jitter will produce no output). The dc-coupled oscilloscope serves

to establish the fact that phase quadrature (zero dc) has been achieved and to examine the character of the noise. (Amplitude noise can be measured in the same setup if the 100-MHz signals are brought to equal, instead of quadrature, phase. In general, amplitude noise is 10 dB or more lower than phase noise.)

When the two frequencies are derived from two similar sources, the phase-noise power observed may be assumed to be twice that of a single source; when one frequency is less noisy than the other by 10 dB or more, its contribution to the observed noise is, for practical purposes, negligible.

The GR 1900 Wave Analyzer is used to explore the phase-noise distribution. A plot of phase-noise power in a 1-Hz-wide band, as a function of the spacing (in frequency) of this band from the carrier is given in Figure 2 for the TYPES 1162, 1163, and 1164 synthesizers. The noise of the reference signal is so low that it can be neglected. We have used a TYPE 1115-B Standard-Frequency Oscillator as a reference at times, and also the 5/5.1 output of a TYPE 1161. In the latter case, the CAD can be used for narrow-band phase lock for convenience.¹

¹ As described more fully in a companion article, this issue, page 3. "The Use of Frequency Synthesizers for Precision Measurements of Frequency Stability and Phase Noise."

The plots of Figure 2 are calculated from experimental data in accordance with the following facts:

(1) When a frequency is multiplied by a factor n , the magnitude of any small-amplitude sideband grows, relative to the carrier amplitude, by the same factor. The "dB down" value measured at 100 MHz must therefore be increased by $20 \log_{10}(n)$ to refer the noise to the actual synthesizer frequency used. If $n = 20$, the frequency correction is 26 dB, and for $n = 100$ the correction is 40 dB.

(2) The noise power in a narrow bandwidth is proportional to the bandwidth (with white noise this is strictly true; with other types of noise, such as the $1/f$ distribution that we observe for synthesizers, it is very close to the truth, provided the bandwidth is small compared with the offset frequency). To check this fact experimentally, the 3-, 10- and 50-Hz bandwidths of the 1900 Wave Analyzer were used at a relatively large displacement from the carrier, and it was confirmed that such calculations from the data of each measurement produced identical values for 1-Hz bandwidth, within experimental accuracy. For the 3-Hz bandwidth of the 1900, then, the dB correction to convert to 1-Hz bandwidth is $10 \log_{10} 3 = 4.77$ dB (rounded out to 5 dB). The 3-Hz bandwidth of the 1900 was used to obtain data for Figure 2.

(3) Measurements made with the circuit of Figure 1 include noise from both the upper and lower sidebands (i.e., the intermediate frequency is zero) and corresponding noise components are coherent. That is, we are actually measuring the phase displacement "Modulation Index" β , which at any frequency (at low modulation index)

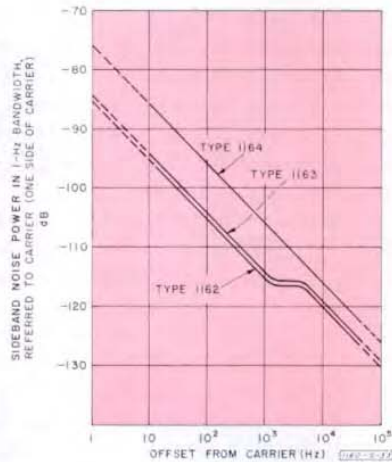

Figure 2. Phase-noise power-density distribution in GR 1160-series synthesizers.

produces an upper and lower sideband, each having an amplitude relative to the carrier of $\beta/2$. Since the associated noise power is proportional to the square of the sideband amplitude, the single-sided noise power is 6 dB lower than the double-sided value measured in the circuit of Figure 1.

(This fact can be experimentally verified by observation of a single discrete component. For instance, if, in the circuit of Figure 1 with $f_s = f_x$, we measure a 120-Hz component as, say, -66 dB, we can then offset f_s or f_x to produce a beat note in the mixer of, say, 10 kHz and measure the sideband spurs, relative to this 10-kHz beat note, at 10,120 Hz and at 9,880 Hz. These now measure -72 dB.)

It has become popular to show "single-sided" noise curves like those of Figure 2, so we have adopted this method of presentation. The 0-dB reference level used is the TYPE 1900 indication of the level of a beat note deliberately set up between the two

100-MHz frequencies by a small offset of f_z or f_s . The 0-dB level we commonly use is 250 mV, rms, which is well within the linear range of the phase detector.

In summary, then, each plotted point on the curves of Figure 2 is calculated from:

dB down = observed dB down at 100 MHz + frequency correction + bandwidth correction + correction to single side.

If $f_z = 5$ MHz, the correction is $26 + 5 + 6 = 37$ dB.

It should be observed that to talk in terms of "phase noise relative to 1 radian," the 6-dB single-side correction should be omitted.

It should also be noted that the curves of Figure 2 apply at any frequency within the range of the synthesizer. For instance, Figure 10 on page 10 shows a series of points taken at 5 MHz ($n = 20$) and another series of points at 1 MHz ($n = 100$) with a typical TYPE 1164 synthesizer. Note that both sets of points fall on the same plot. This condition exists because the synthesizers are beat-frequency oscillators, and what we are really measuring is the noncoherent noise on the inputs to the final output mixer.

The 1164 plot is about 8-dB noisier than the plots for the 1162 and 1163. However, the 1164 goes to much higher frequencies, so that, if the output is going to be multiplied to some still higher frequency (like 1 or 2 GHz), the 1164, with its higher possible starting frequency, will generally come out ahead. If the synthesizer frequency is to be added to some less noisy precision microwave frequency, the 1162 or 1163 will produce a slightly better result, provided the available

frequency range is adequate and the combining circuits can be properly worked out.

A striking fact exhibited by Figure 2 is that the noise power density falls off inversely with offset frequency. Note that the curves in Figure 2 have a falling slope of 10 dB per decade, or 3 dB per octave. (In the 1162 and 1163 there are some small anomalies in the region beyond a 2-kHz offset, which are not yet satisfactorily explained.)

Since this is experimentally true, it is convenient to define the noise power density very simply, for comparison purposes, by a single number, namely the "dB down" figure at the intercept of the 10-dB-per-decade line with the 1-Hz offset ordinate. From Figure 2, these figure-of-merit numbers are:

Synthesizer	Noise Power Density at 1-Hz Offset
1164	-76 dB
1163	-84 dB
1162	-85 dB

Given this number, one can at any time reconstruct the curve, accurately enough for most purposes, by drawing a line with 10-dB-per-decade negative slope through the tabulated point.

It should be noted that the curves of Figure 2 show the average of measurements on eight or ten production synthesizers of each type. Individual measurements vary about ± 2 dB around these averages.

Note Regarding Type 1161

No data on the TYPE 1161 are presented here, because we have not as yet made measurements in this type of setup. Presumably the data, when obtained, will show the same slope, and

a 1-Hz intercept 20-dB lower (theoretically) than the TYPE 1162, or about -105 dB. (This is not yet a measured value, however.)

For most purposes, noise data on the 1161 are not as important as data for the others, since such information is

chiefly of interest where frequency multiplication of the output signal is planned. We do not expect many such applications for the 1161 (or for the 1162, for that matter), in view of the availability of the TYPES 1163 and 1164.

— ATHERTON NOYES, JR.



Figure 1. Type 1160-P2 Sweep and Marker Generator.

A SWEEPER FOR GR SYNTHESIZERS

The introduction of the 1160-P2 Sweep and Marker Generator (Figure 1) extends the usefulness of the already versatile General Radio Synthesizers by providing a convenient means of varying the synthesizer output frequency at a controlled known rate and through an accurately known range. The instrument also supplies markers for easy visual monitoring of the continuous band of frequencies generated. Several additional features facilitate frequency-response testing of active and passive networks and frequency-selective instruments. These include a wide choice of automatic sweep speeds, a calibrated center-frequency marker, accurate adjustable side markers, and a simple means of expanding the sweep

coverage about any stable synthesized center frequency.

To understand the way in which the sweeper operates, remember that the continuously adjustable decade (CAD)¹ in GR synthesizers can be functionally substituted for all step-digit modules below a chosen rank, and that the frequency of the CAD can be varied by an external control voltage of approximately 0.3 volt per CAD major division. In each synthesizer, built-in monitor circuits permit calibration of the CAD frequency against the frequency generated by the replaced digit modules. In addition, the deviation of the CAD frequency from that represented by the

¹ Atherton Noyes, Jr., "Coherent Decade Frequency Synthesizers," *General Radio Experimenter*, September 1964.

replaced digit dials is continuously monitored and is available at the synthesizer BEAT terminals. This continuous monitoring can be used to produce an accurately defined center-frequency marker and side markers indicating known deviations from center frequency.

In use, the Sweep Unit is connected to any GR synthesizer and to a display device. A storage oscilloscope is especially desirable at lower sweep rates. All input and output connections are available in parallel at both the front and rear of the Sweep Unit, to suit the requirements of any setup.

The sweep voltage supplied to the EXT CAD control input to vary the CAD frequency has a triangular waveform. The resulting sweep amplitude is continuously adjustable from ± 1 CAD division to ± 10 CAD divisions by the FREQ EXCURSION control. A synchronized sweep voltage, of constant amplitude, is available for horizontal deflection of the display device. The triangular, or two-way, sweep control permits the user to observe the effects of the sweep time on the response of the device being tested. Nine one-way sweep times, ranging from 20 milliseconds to sixty seconds, are provided. If narrow-band devices are swept at a

faster rate than the response time will accept, a characteristic leaning of the response display will be easily detected visually, since the forward and backward traces will lean in opposite directions and fail to coincide.

When the function switch is in the MANUAL position, the frequency sweep and the synchronized deflection-voltage sweep are manually controlled, and the sweep follows the position of the MANUAL control. This mode is sometimes useful for close examination of a critical portion of a response. With the CAD FREQ EXCURSION control, one can change the swept frequency coverage *without changing the display width and without affecting the selected center frequency*. Markers always indicate actual frequency and move as required when sweep excursion is changed.

An internal oscillator, step-adjustable by two decade controls, provides a reference signal for generating side markers. This marker oscillator is calibrated in terms of the CAD dial divisions departure from the synthesizer center frequency, as chosen by the operator. The synthesizer BEAT output always changes by 10 kHz for each major CAD division swept.¹ The variation in output frequency correspond-

¹ Ibid

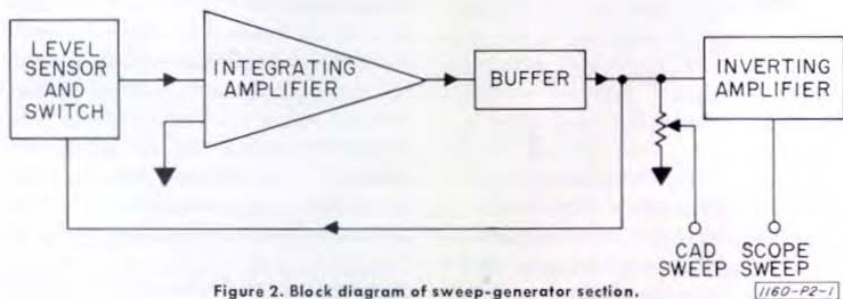

Figure 2. Block diagram of sweep-generator section.

[[160-P2-1]]



Robert L. Moynihan is a graduate of Northeastern University, where he received the BSEE degree in 1959 and MSEE degree in 1961. Before joining GR, he served for two years in the US Army Signal Corps working on advanced radar R&D, was an instructor of electrical engineering at Northeastern, and a senior engineer at Sylvania Electronic Systems, where he developed subsystems for use in phased-array radar. At General Radio, he is a development engineer in the Decade-Frequency Section of the Signal-Generator Group.

ing to a CAD dial division, on the other hand, can be selected in decade steps with the synthesizer pushbuttons. The marker oscillator generates frequencies from 10 to 59 kHz in 1-kHz steps (each corresponding to one minor division of the CAD dial). The marker-oscillator signal is mixed with the BEAT signal of the synthesizer, and markers occur whenever the BEAT and the marker oscillator frequencies are equal.

Markers appear at symmetrical spacings above and below the center-frequency marker. The center-frequency marker occurs when the BEAT frequency itself is zero and is distinguishable by its bipolar characteristic on the display. It always indicates the point at which the swept frequency is exactly the frequency set by all the synthesizer digit units (including those functionally replaced by the CAD). As the sweep rate is raised, the side markers have less time for buildup and gradually disappear. The center-frequency marker holds position* and always serves as a reassurance that the center frequency is as selected. Side markers can be checked or position by a momentary reduction in sweep speed.

Markers cannot be placed closer to the center frequency than 1 CAD division. Such close-in markers are unnecessary because of the extremely good linearity of the CAD sweep below 1 division. To subdivide this frequency region, one merely positions the 1-division marker at a suitable line on the oscilloscope graticule (by adjustment of the oscilloscope horizontal gain) and uses the graticule divisions as vernier markers.

HOW IT WORKS

Sweep-Generator Section

The sweep-generator section is shown in Figure 2. The sweep-voltage output is obtained by integration of a step of voltage in an operational amplifier with capacitive feedback. The differential-input section is balanced to ground so that either positive or negative inputs are amplified and integrated with polarity retained. The output of the amplifier is monitored by a level sensor which, at preset positive and negative voltage extremes, applies a reversed-polarity step of voltage to the integrator. Sweep rates are adjusted by variation of input step amplitude and of the integration time of the amplifier. The amplitude of the resulting triangular output-voltage waveform is maintained constant by the level sensor. Subsequent buffering and adjustable attenuation result in controlled-rate variable-amplitude sweep voltage. In a second channel, an inverting amplifier is used to obtain a synchronized horizontal-deflection sweep signal of constant amplitude and opposite polarity. (Inversion is needed, because the synthesizer frequency increases with *negative* sweep voltage,

* At high sweep speeds the center-frequency marker changes character but remains symmetrical, so that its center is still well defined and obvious.

whereas oscilloscopes deflect to the right for *positive* voltage.)

Marker Section

The reference oscillator for the frequency markers is a transistorized Wien-bridge oscillator (Figure 3), whose frequency is determined by the relationship $f_o = G/2\pi C$ when the resistance and capacitance values in the series arm equal those in the shunt arm of the Wien bridge. The frequency of the oscillator is controlled by simultaneous variation of the conductances of the shunt and series arms. This is accomplished by the switching of two parallel banks of precision resistors in shunt to obtain multiples of G_o (10 kHz = $G_o/2\pi C$). One switch selects multiples of G_o and the second selects $0.1\text{-}G_o$ increments. The oscillator produces frequencies from 10 to 59 kHz in 1-kHz increments with 1% tolerance. These frequencies correspond to CAD dial divisions ranging from 1 to 5.9 in 0.1-division steps. A negative-temperature-

coefficient thermistor in the negative-feedback divider of the bridge keeps the output amplitude constant at all frequencies.

The oscillator output is mixed with the BEAT signal from the synthesizer, and subsequent narrow-band filtering and rectification produces sharp, accurate markers.

APPLICATIONS

Since the synthesizer design is such that one CAD division can correspond to an output frequency range anywhere from 0.001 Hz to 100 kHz as chosen by pushbutton, the system provides an extremely wide choice of sweep widths, sweep rates, and marker spacing about a selectable crystal-controlled center frequency. Slow sweep rates are required with narrow-band devices so that the full amplitude of the response can be reached. A crystal filter, for example, is energized by the source during only that part of the sweep range when the output is within the

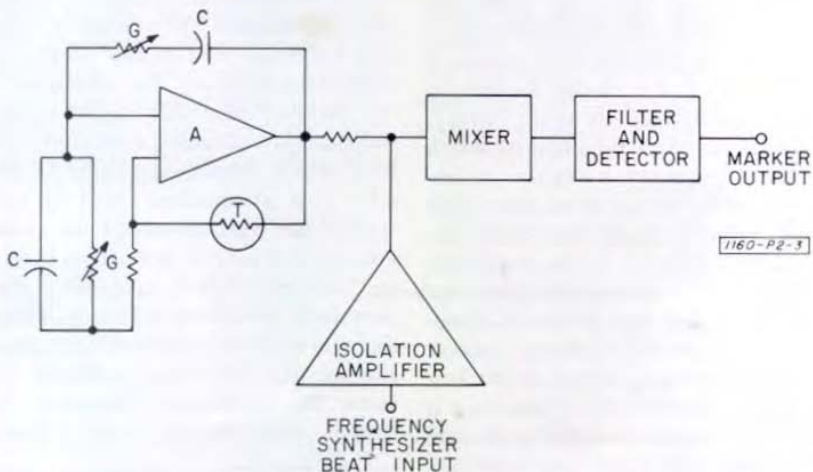

Figure 3. Diagram of marker-generator section.

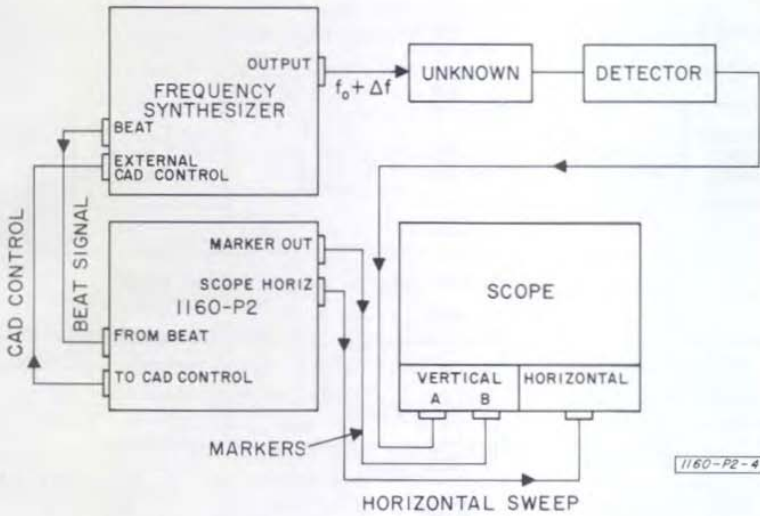

Figure 4. Block diagram of sweep unit and synthesizer used as a precision swept source.

bandpass of the device. Narrow sweep widths are necessary to keep the signal within the bandpass for a reasonable percentage of the sweep time and to yield an expanded display for convenient analysis. The level output and constant source impedance of the synthesizer are also important factors in achieving useful and reliable response testing of crystal and mechanical filters and frequency-selective instruments.

Figure 4 is a block diagram of the sweep unit and synthesizer combined as a precision swept source. The response of a 50-MHz crystal filter is shown in Figure 5. The CAD was in the $\times 10$ -kHz position and the side markers were set for ± 1 CAD major division (i.e., ± 10 kHz at the output frequency). The response of the GR 1900 Wave Analyzer is shown in Figure 6. The CAD was in the 10-Hz position and was swept $\pm 2\frac{1}{2}$

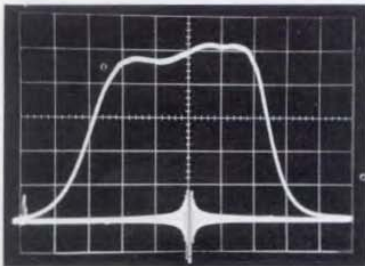

Figure 5. Response of 50-MHz crystal filter. Horizontal scale: 2 kHz/cm. Center frequency marker: 50.00000 MHz.

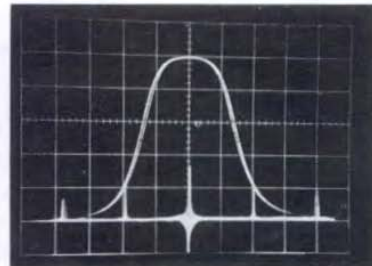

Figure 6. Response of GR 1900 Wave Analyzer tuned to 10 kHz and set for 10-Hz bandwidth. Horizontal scale: 5 Hz/cm. Center frequency marker: 10,000.00 Hz.

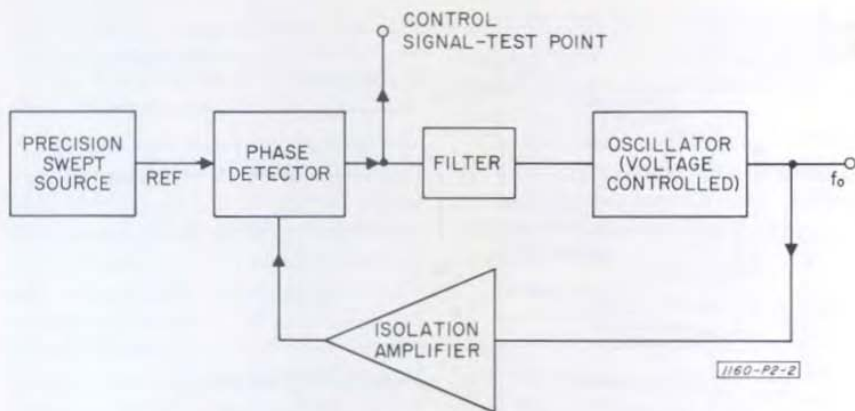

Figure 7. Setup for swept-frequency evaluation of phase-locked loop.

major divisions, or ± 25 Hz at the output frequency. The side-marker setting was 1 CAD major division. Markers at ± 20 Hz also appear; they are created by the mixing of second harmonics of the BEAT and marker-oscillator signals.

Another application involves the study of a phase-locked oscillator, a device often used as an active bandpass filter in frequency multipliers and phase-locked telemetry receivers. Proper operation of such oscillators is established by measurement of several parameters, including lock range, capture range,¹ and loop stability. Figure 8 is an elementary block diagram of a possible test setup using the precision frequency swept-source. The reference signal is swept at a controlled rate and width, and the control signal of the lock loop is monitored, providing useful information regarding lock-loop performance and stability. The control signal during lock is a ramp. When the reference signal is swept outside the

lock range, the control signal becomes a dc level plus an ac signal representing the beat between the reference and the free-running oscillator. The display (Figure 8) is easy to interpret visually, and the results of adjustments can be seen immediately. Loop bandwidth can be measured and center frequency adjusted on the production line.

Measurements need not be confined to the frequency range of present synthesizers. Suitable wide-band multi-

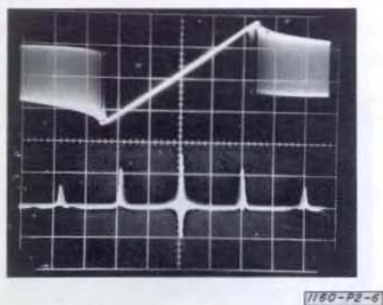

Figure 8. Oscilloscope presentation resulting when 5-MHz phase-locked oscillator was swept with 1163 synthesizer and 1160-P2 sweep generator. Sweep display is 25 kHz either side of 5 MHz; markers are at 10-kHz spacing. Lock range (equals capture range) is approximately ± 12 kHz about 5-MHz center frequency.

¹ McAloer, H. T., "A New Look at the Phase-Locked Oscillator," *The Proceedings of the IRE*, Vol 47, June 1959, pp 1137-1143.

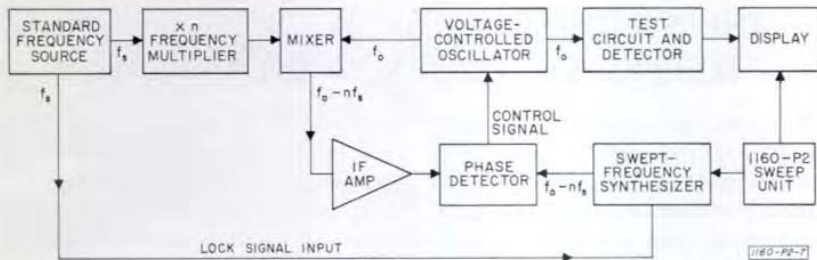

Figure 9. Block diagram of a frequency-conversion system.

pliers or converters can be used to translate the frequency-swept synthesizer to the uhf range when required. One method of extending the frequency coverage is to multiply the output frequency of the synthesizer. In such a system, the swept frequency excursion, Δf , of the synthesizer is of course increased by the chosen multi-

plication factor (and any phase noise of the synthesizer is also multiplied).

Another method, diagrammed in Figure 9, translates the synthesizer frequency to another region of the spectrum by frequency addition. In such an arrangement the swept frequency excursion is unchanged.

— R. L. MOYNIHAN

SPECIFICATIONS

AUTOMATIC SWEEP

Sweep Voltages: Symmetrical triangular waveforms centered on 0 V dc.

Time for One-Way Sweep: 0.02 to 60 s, automatic, selectable in 9 steps. **Sweep-Time Accuracy:** $\pm 10\%$.

Outputs: CAD sweep is continuously adjustable from ± 1 to ± 10 major CAD divisions (± 0.3 to ± 3 V approx). The SCOPE HORIZ output is nonadjustable (12 V, p-to-p, behind approx 10 k Ω).

MANUAL SWEEP

Outputs: Sweep excursions are the same as in automatic mode, with continuous manual control.

MARKERS

Location: Center marker occurs at the frequency set on synthesizer digit dials. Side markers are displaced symmetrically from the center marker by the amount set on the MARKER SPACING dials.

Side Marker: Spacing from center marker can

be from 1 to 5.9 CAD divisions in 0.1 steps.

Accuracy: $\pm 1\%$ of dial setting.

GENERAL

Power Required: 100 to 125 or 200 to 250 V, 50-400 Hz, 3W.

Ambient Temperature: 0 to 50°C.

Accessories Supplied: Two 2-foot (TYPE 1160-0320) and two 4-foot (1160-0321) BNC coaxial patch cords, CAP-22 3-wire power cord, spare fuse.

Terminals: Connections to synthesizer and MARKER OUT and SCOPE HORIZ outputs available front and rear.

Cabinet: Rack-bench. End frames for bench mount and fittings for rack mount are included.

Dimensions: Bench model — width 19, height 2, depth 14 $\frac{1}{2}$ inches (485, 52, 370 mm), over-all; rack model — width 19, height 1 $\frac{3}{4}$, depth behind panel 13 $\frac{1}{4}$ inches (485, 43, 330 mm).

Weight: Net, 12 lb (5.5 kg); shipping, 16 lb (7.5 kg).

Catalog Number	Description	Price in USA
1160-9600	1160-P2 Sweep and Marker Generator	\$495.00

THE SYNTHESIZER IN THE PRODUCTION TESTING OF PRECISION DELAY LINES

The recent development of coherent frequency synthesizers has made available extremely precise, direct-reading frequency sources for general laboratory measurements and production testing. Some of the many applications for these versatile instruments have been mentioned in earlier *Experimenter* articles. The following is a brief description of the interesting way in which one manufacturer uses a synthesizer to calibrate ultrasonic delay lines.

Delay-Line Applications

Delay lines are widely used to provide transient, readily accessible memories, either analog or digital, in computers and in systems for processing radar echoes (e.g., video pulse integrators and moving-target indicators).

In these applications, delay lines must store pulses for long times — several milliseconds — with very little deg-

radation of the original shape. Wide bandwidth and very little dispersion must be achieved. The delay line must also meet stringent specifications with regard to spurious responses and stability.

The Solid Delay Line

These requirements are met by solid ultrasonic delay lines using fused quartz or glass as the propagating medium. Solid media propagate both longitudinal (compression) and transverse (shear) acoustic waves. Because of its lower velocity, the transverse mode is utilized in delay lines. The velocity of transverse waves in fused quartz is 0.148 in/ μ s or 12,300 ft/s, about 11 times the speed of sound in air. A 30-MHz signal traveling with this velocity has a wavelength of 0.00493 inch.

For short delays, up to 50 μ s, a single bar is used with a transducer on each

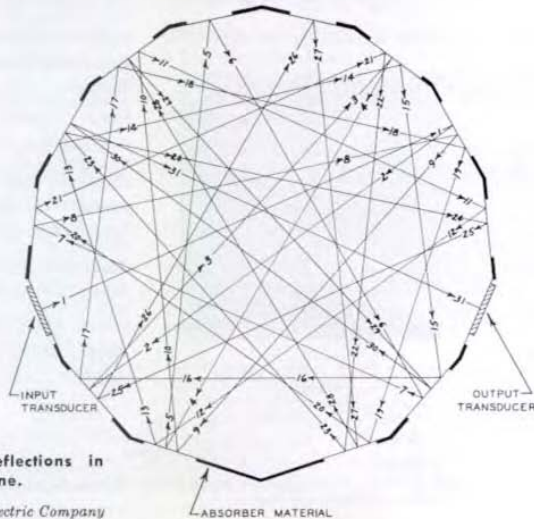

Figure 1. Multiple reflections in 31-pass quartz delay line.

Courtesy Bliley Electric Company

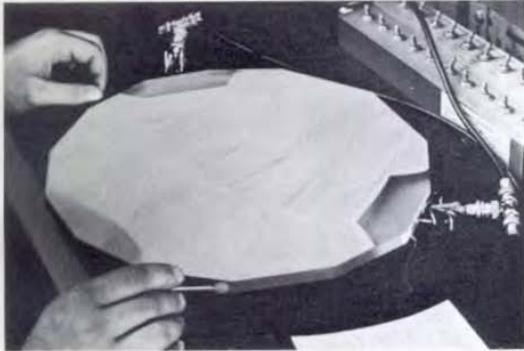

Figure 2. Fused-quartz line during manufacture.

Courtesy Microsonics, Inc.

end, but for longer delays, to save weight and space, the propagation path is folded inside a flat, polygonal slab by means of internal reflections at the sides. Figure 1 shows a complex design in which the wave is made to traverse the slab 31 times in order to achieve a long delay; Figure 2 shows the line itself, unhoused, during production. The input and output transducers are piezoelectric quartz crystal or ceramic wafers cemented to the slab. In order to suppress spurious responses, surfaces not in the path of the main beam are doped with absorbing material.

Delays up to 200 μ s can be obtained with a special glass having a zero temperature coefficient of delay. For longer delays, however, the high attenuation of the glass prohibits its use and the line must be made of fused quartz, whose temperature coefficient of delay

is -75 parts per million per degree Celsius. In many applications, quartz lines must be very precisely temperature-controlled to provide the necessary stability of delay.

Delay-Line Measurements

Extremely tight tolerances in delay-line specifications require precise measurements of delay time and of other characteristics during manufacture. For example, a line used for digit storage in a computer's memory may have a delay of several milliseconds that must be held to a tolerance of a nanosecond, or to a few parts in 10^7 . Microsonics, Inc., a manufacturer of delay lines, has developed a fast, direct-reading method for making precise delay-time measurements with a frequency synthesizer.

Figure 3 shows how it is done. The oscillator frequency is the center fre-

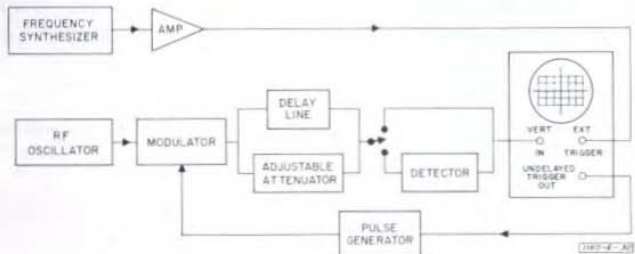

Figure 3. Equipment setup for measurement of delay line.

GENERAL RADIO COMPANY
WEST CONCORD, MASSACHUSETTS 01781

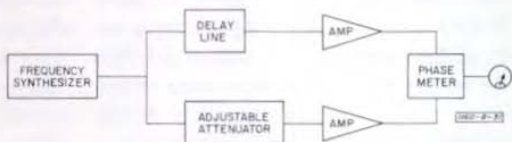

Figure 4. Equipment setup for measurement of stability of delay line.

quency of the line's passband. The oscillator output is pulse-modulated at a repetition rate derived from the synthesizer, which also synchronizes the oscilloscope. The delay line is paralleled by an attenuator, and both delayed and undelayed pulses are displayed on the oscilloscope screen. The two pulses coincide if the pulse rate, $f_{synthesizer}$, is exactly a multiple n of $1/\text{delay time}$, which we will refer to as the repetition frequency of the line, f_{line} . That is, at coincidence, $f_{synthesizer} = n f_{line}$. If n is made some power of 10 the synthesizer dials read directly the repetition frequency of the delay line. The pulse envelope from the detector is used to achieve rough coincidence; then the detector is switched out and the rf pulses themselves are compared to

provide a vernier reading. At a typical frequency of 30 MHz the measurement is accurate to about ± 1 nanosecond. Additional measurements of delay at the lower and upper ends of the passband determine the line's dispersion.

Another measurement requiring the synthesizer's precision is that of the temperature-control oven's ability to maintain stability of the delay time. In this case the synthesizer provides a cw signal at the line's center frequency. As shown in Figure 4, the phases of the delayed and undelayed rf carrier are compared with a phase meter. The method measures drift in the delay time with a precision corresponding to 1 degree of phase, or 1/10 nanosecond at 30 MHz.

— D. A. GRAY

GENERAL RADIO COMPANY
WEST CONCORD, MASSACHUSETTS 01781